

Haier

TOP LOAD FULL-AUTOMATIC WASHING MACHINE **USER'S MANUAL**

MODEL
HWT60AA1
HWT75AA1

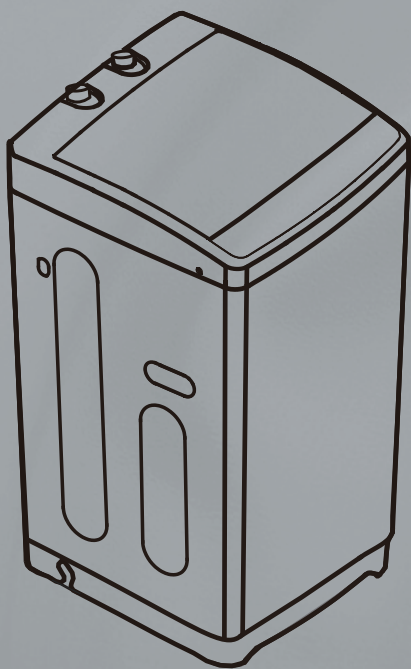

Please read this manual carefully before operating your washing machine and retain it for future reference.

0030517190A



CONTENTS

■ Product overview	1
■ Safety precautions	2
Description of symbols	2
Safety	2
Safety warnings	2
■ Installation & adjustment	4
Installing the bottom plate	4
Balancing the washing machine	5
Installation of the drain hose	5
Installation of water inlet hoses	6
■ Before washing	7
Check the following before washing	7
■ Operation	8
Loading your laundry	8
Loading detergent	8
Explanation of the display	9
■ Operation and Wash Cycles	12
■ Cleaning and Maintenance	14
■ Trouble-shooting	15
■ Packing list	16
■ Specification	17

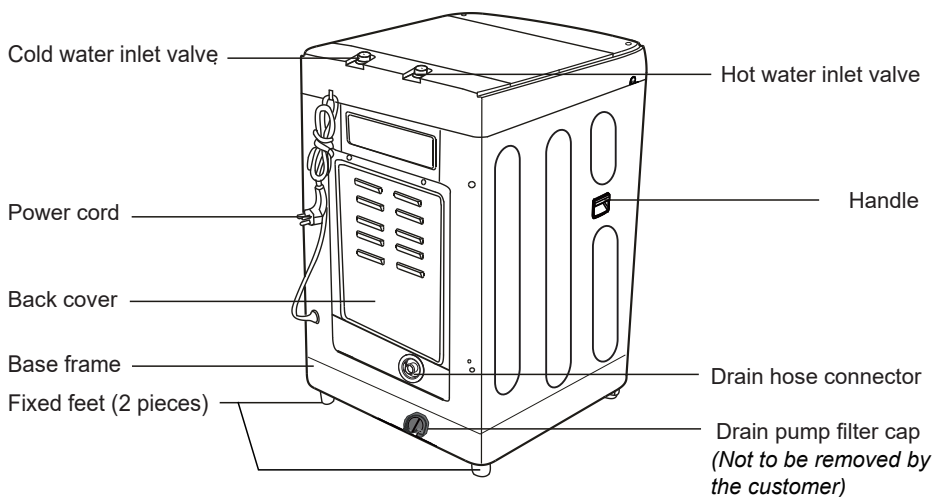
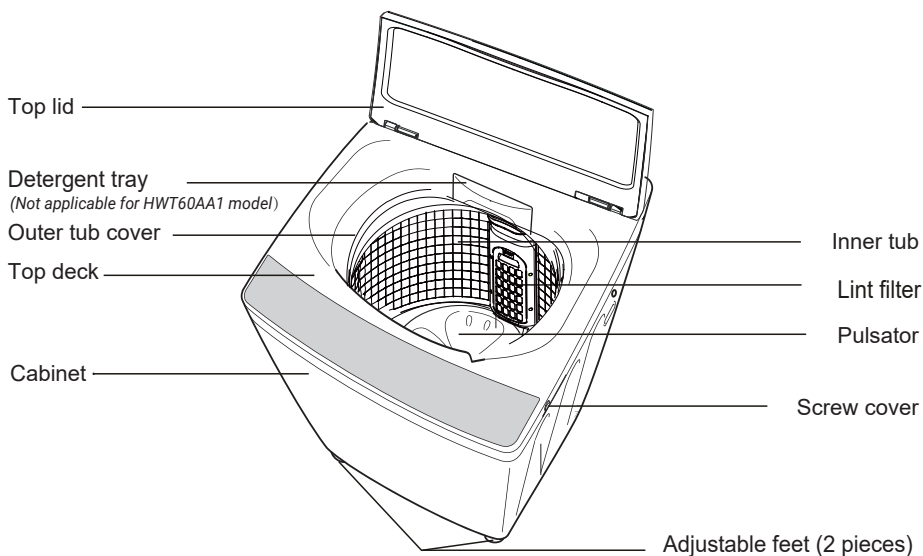

Product overview



Please understand the shapes of the washing machine and accessories may be different from the sketch figures in this manual due to product improvement.

Safety precautions

Description of symbols





Warning sign 	Contents marked with this symbol are related to the safe use of the product and the personal safety of the user. Please operate in accordance with the contents of this manual to avoid harm to the user or damage to the machine.
Forbidden sign 	Contents marked with this symbol indicate operations or actions that should not be undertaken by the user. Performing of such actions may result in an injury to the user or damage to machine and void the warranty.

Safety

This appliance is intended to be used in household and similar applications such as:















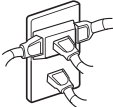





- ... staff kitchen areas in shops, offices and other working environments;
- ... farm houses;
- ... by clients in hotels, motels and other residential type environments;
- ... bed and breakfast type environments;
- ... areas for communal use in blocks of flats or in launderettes;
- ... max. capacity 6kg (HWT60AA1), max. capacity 7.5 kg (HWT75AA1), water pressure 0.03-1MPa.

Warning

<p>A separate, earthed power socket is required for the power supply. Hold the plug, not the electric cable, when unplugging the washing machine. Do not insert or remove the power plug with wet hands. The power plug should be accessible after machine installation.</p> 	<p>Ensure the plug is removed and the taps are turned off in the following cases. Power failure, cleaning, moving, installation of the machine and when not in use.</p> 
<p>If the Power cord is damaged, it must be replaced by the manufacturer, its service agent or similarly qualified people in order to avoid a hazard. CAUTION: If this appliance is supplied from a cord extension set or electrical portable outlet device, the cord extension set or electrical portable outlet device must be positioned so that it is not subject to splashing or ingress of moisture.</p>  	

Safety precautions

Forbidden

<p>Do not install this appliance in a damp or wet environment. Do not leave wet laundry on the Control Panel or spray water directly onto this appliance as this may cause the washer to malfunction or cause an electrical fault.</p>	 	<p>Do not connect to hot water higher than 60°C temperature.</p>	 
<p>If you are using an extension cord or a portable electrical outlet device (not recommended), ensure that it is positioned so that it does not come into contact with water or moisture.</p>	 	<p>Do not wash water-proof clothing as this may affect load balance during spin cycle(s).</p>	 
<p>Do not attempt to remove washing or place hands inside the washing machine while in operation. Please ensure children are supervised around the machine to avoid harm.</p>	 	<p>Do not take apart, repair or alter the machine by yourself.</p>	 
<p>Do not leave hot or heavy items on the lid or control panel as this may cause damage to the washer or make the washer unsafe to operate.</p>	 	<p>Do not wash laundry with chemicals or other volatile materials (such as petrol, solvents or thinners) as this may cause damage to the machine.</p>	 
<p>This appliance is not intended for use by persons (including children) with reduced physical, sensory or mental capabilities, or lack of experience and knowledge, unless they have been given supervision or instruction by a person responsible for their safety. Children should be supervised to ensure that they do not play with the appliance.</p>	 	<p>Keep washer away from heat sources such as heater, stoves or direct sunlight.</p>	 

Safety precautions

- If power cord or other parts of this machine become damaged or faulty, please contact a technician to have it repaired. Do not attempt repairs by yourself as this may cause personal harm or void warranty.
- The new hose-sets supplied with the appliance are to be used and the old hose-sets should not be reused.
- Please do not to remove the pump filter cap situated at the bottom rear of the product in any situation as water remaining in the product will flow directly out of the product.
- In the event of a blockage or a failure to drain, please contact the customer care centre for assistance.
- The pump filter cap is only to be removed by a trained service technician.

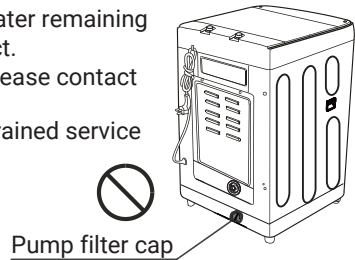

Installation & Adjustment

Please install and adjust the machine according to the directions contained in this manual. It is very important to follow these directions for the safe operation of the machine, and to ensure your machine operates correctly.

Installing the bottom plate

The purpose of the bottom plate is to suppress noise from the washing machine during operation

Steps:

1. Tilt the machine backwards against a wall. (ensure that the machine is well supported)
2. Place the plate onto the bottom of the machine.
3. Use a screwdriver to tighten the screw (in accessory bag) securing the panel to the bottom of the washer.
4. Once the screw is tight and the panel is secure, return the washer to its standing position.

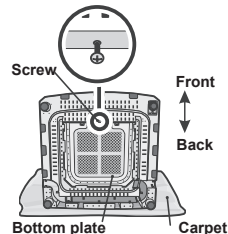

Note: The washing machine has ventilation openings in the base, the product must not be placed on a carpeted surface.

Installation & Adjustment

Balancing the washing machine

Installation on an uneven surface can lead to 'out of balance' events, instability in the machine operation, or even failure to successfully complete a wash cycle. Please refer to the following method for adjustment:

1. Confirm whether the machine is level.
2. Lift the lid and ensure that the bowl is central to the top deck opening.
Adjust the two front leveling feet as necessary.

Note: The distance between the washing machine and the wall should be at least 20mm.

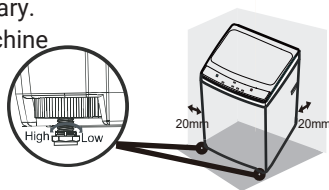

Drain hose

1. Remove the cap of the drain hose outlet.

Note: A small amount of water may come out when the cap is removed. This is normal as there maybe some water left in the pump as the machine is tested during manufacture.

2. First connect the drain hose to the connection point on the lower right side of the cabinet, and fasten with drain hose clamp (provided).
3. Connect drain hose guide on to the outside of drain hose. To guide the drain hose over the tub or standpipe, the bracket **MUST** be fitted to the drain hose.

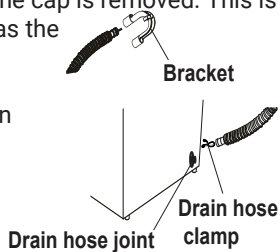

1. The height of the standpipe or tub should be between 0.8 - 1.2 m.
 2. To avoid syphoning, the drain hose should not extend more than 20 mm from the end of the guide.
- Ensure drain hose is held in place to avoid leaks or spills.

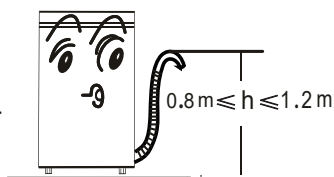

Installation & Adjustment

Water inlet

1. Connect the cold hose (blue connector) to the cold tap and the hot hose (red connector) to the hot tap. You may have to use pliers to tighten the coupling. Do not over tighten as this may cause damage to the valve or hose fittings.
2. Connect the other end of the hose to the respective hot and cold inlet valves, located at the rear of the washing machine.
3. We recommend replacing the inlet hoses every 5 years. Hoses should be checked from time to time and replaced if any wear, damage or leaks are found.

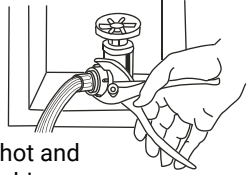

Connection between the water inlet hose and the washer

1. Do not take off the water absorption cushion. Please check if the cushion has dropped off or is damaged before attaching to the washing machine. If this happens please contact our after-sale department immediately.
2. Put the nut of the water inlet hose onto the inlet valve thread.
3. Fasten the nut.

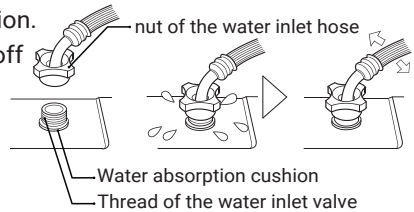

Check the inlet hose connections

1. Swing the hose gently to confirm that the hose is securely fastened and can pivot as required.
2. After installation, open the tap to check for leaks.
3. Do not bend the hose unduly.
4. Periodically check the hose connections are firm at both ends. This is to ensure the connections remain water tight over time.



Before washing



Preparation before washing

1. Connect the water inlet hose. Open the water faucet.
2. Insert the power plug into the wall power socket.
3. Ensure the drain hose is mounted at the correct height.
4. When the water pressure in the user's home is too low, it may not be able to wash detergents and softeners effectively (which may agglomerate).
5. Please clean the detergent box when required to maintain a clean surface.

It is suggested to dilute the detergents before putting laundry into the inner tub. It is suggested that the softener be diluted and put into the inner tub directly after the last rinse.

6. Before washing we recommend that a "Drum Clean" cycle is run without any clothing.

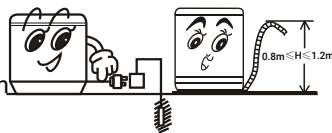

Check the following before washing

Clear the pockets and take out loose items such as coins, sand, hairpins etc.



Tie any long straps or strings, fasten buttons and close zippers



The weight of the laundry shall not exceed the rated capacity of your machine, loosen the laundry before placing it evenly in the tub. Make sure the clothes are completely placed in the inner tub.



When the machine is running, buttons may cause noise.

To reduce the noise, turn clothes inside out or place them in a laundry bag.



- a. Check if the laundry has any special washing instructions.
- b. Divide the laundry into colour fast and non-colour fast items. When washing jeans and other easily discolored clothes, please soak them with water first. After soaking, put into the washing machine.
- c. Separate items that do not absorb water easily and wash by hand. Make sure the clothes are wet before washing, such as Wool
- d. For heavily soiled items, please first remove loose dirt.
- e. For those items that may attract lint, please turn inside out before washing.
- f. Do not put laundry soiled with chemicals or solvents into the washing machine.
- g. When washing cotton clothes with strong water absorption, such as bed sheets and quilt covers, it is recommended to increase the water level manually after the default water level is completed. Increasing the water level can improve wash performance.

Operation

Loading your laundry

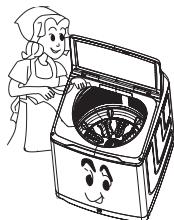

- The rated washing capacity refers to the largest dry weight of a load that can be washed.
 - The thickness, size and type of clothes will influence the actual capacity.
 - Do not select more than water level "Mid" for clothes less than 2.0kg, to avoid splashing of water.
 - It is recommended that low suds/high efficiency washing powder is used.
- Before washing, please make sure that the water level covers the clothes. Adjust the number of clothes according to the actual situation. The clothes load should not exceed the height of the metal drum surface.

Adding washing power

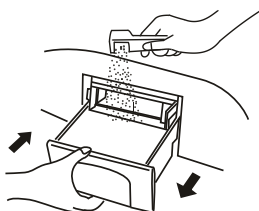

Note: The HWT60AA1 model does not have a detergent box. You need to pour the detergent into the drum directly.

- It is suggested to dissolve detergent before adding to the tub, see as below:
 1. Prepare warm water (<math><35^{\circ}\text{C}</math>) in a container.
 2. Add washing powder, stirring to dissolve it completely.
 - **Adding washing powder**

It is recommended that washing powder/liquid is dissolved with water and then directly emptied into the washing machine: (not applicable for Fuzzy Logic and Delay program)

 1. Add some water (select the "Low" water level)
 2. Add washing powder/liquid. Run for about 30s to fully dissolve the detergent. Then push the "START/Pause" button to pause the wash cycle.
 3. Load laundry. Select suitable water level.
 - If you select "Express" program, it is recommended to use liquid detergent instead of washing powder to ensure the most effective wash results.
 - Old or poor quality washing powder may causing caking in tub or detergent dispenser.
 - When water pressure is too low, it is possible that washing powder or washing liquid cannot be washed away effectively, and washing powder or washing liquid would be agglomerated after a period of time. Please clean the detergent box in time. It is recommended to pour the washing powder or liquid into the basket directly
- Note: For best wash performance, use low suds/High Efficiency detergent and dissolve the detergent in <math><1\text{L}</math> warm water prior to mixing with laundry.

Close the lid

If you open the lid during all cycles the machine will stop and an audible alarm will sound.

Operation

Explanation of buttons

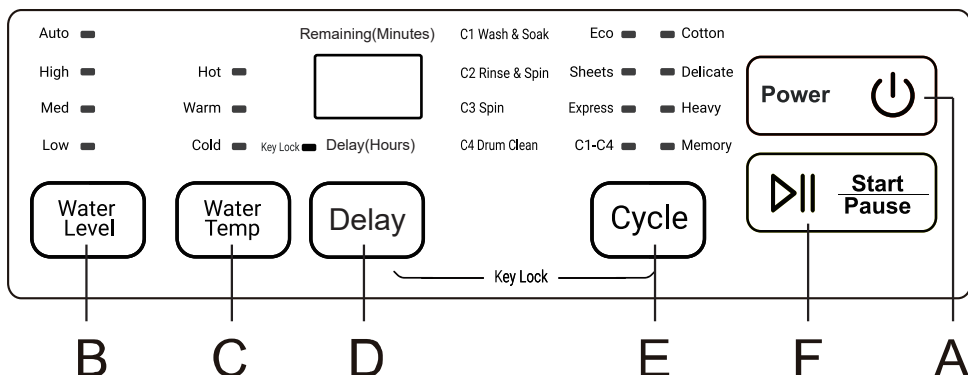

Indicator display

- Off
- On: Indicates the program is running and indicates the selected cycle and options
- Flashing: When paused, indicates the progress status of the current washing cycle.

Key Lock function

- The function is intended for child safety and preventing the washing program from accidental changes by children.
- Push the Power button, set the desired washing program, after setting, press the "Start/Pause" button, then hold the "Delay" button and "Cycle" button at the same time for more than 1 second. The digital display "CL", the child lock. All of the buttons are locked, and will not function.
- To release the key lock function: press "Cycle" button and "Delay" button at the same time for more than 1 seconds. After one beep sounds, the child lock function is released. The child lock light goes out.

Note: After the key lock is released, press the Start/Pause button to open the lid. If the lid is forced open when washing, the machine will alarm E2 and stop running. The machine will automatically drain after 10 seconds. If you confirm the safety, please close the lid and press "Start/Pause" button to wash the clothes. The machine will continue to operate. If a separate washing or rinsing process is selected, the washing machine will drain automatically after operation.

Operation



Digital display

■ During the wash cycle, the digital display will show the time remaining in minutes.

■ If an issue occurs, the display will show a user warning or error code (see to page 15)

■ If a 'Delay start' is selected, the display will show the total time to cycle completion including the delay period, in hours

Page 15



Power

A "Power" button

■ Push the " Power " button to switch on the power.

■ Under power-on mode, push it to switch off the power.

■ If the "Start/Pause" button is not pushed, the machine will switch off the power automatically after 10 minutes.



Start
Pause

F "Start/Pause" button

■ After the power is switched on, press it to start the machine.

■ To pause the wash cycle, press the "start/pause" button.

■ To restart a wash cycle, press the "start/pause" button again .

E "Cycle" select

Cycle

Cycle	Application
Express	Quick wash for smaller lightly soiled loads & brand new clothes
Eco	The water saving cycle
Sheets	A cycle specifically designed to wash sheet loads
Delicate	Gentle wash action with slow spin speed
Cotton	Warmer wash for cotton clothing
Heavy	Use this cycle to wash durable,full load, suitable for towels, children clothes, workwear
Memory	This cycle setting remembers the last wash, rinse and spin settings for a particular cycle
C1 Wash & Soak	Selection adds a soak period to the wash cycle. When the washing is complete, the cycle will progress to rinse and spin
C2 Rinse & Spin	Use this cycle to relax wrinkles, remove excess detergent and refresh clean clothes.
C3 Spin	Use this cycle to remove water from clean clothes
C4 Drum Clean	Cleaning the inner and outer tub to avoid the growth of mildew Do not put any clothes in the inner tub

Operation

Water level	B "Water Level" button <ul style="list-style-type: none">■ Press the water level button to select the water level you want to set.■ When there is water or wet clothing in the tub, it can't automatically detect the clothes quantity.■ All of the cycles except Drum Clean cycle default to show "Auto" water level, you can choose another water level manually. The Drum Clean cycle defaults to show "High" water level.■ If you choose "Auto", the machine will detect the clothes quantity and automatically select the suitable water level .■ During Wash and Rinse, press the water level button to adjust the water level. Because of the different wet and dry degree of clothes, the water level judged will be different. Please choose the water level according to the load.
Water Temp	C "Water Temp" button <ul style="list-style-type: none">■ Press the "water Temp" button to select your wash temperature.■ During ECO, Delicate cycles, "Warm hot" and "Hot" temperatures cannot be chosen.■ During Drum clean cycles, "cold", "warm cold" and "warm" temperatures cannot be chosen.■ During C2 Rinse & Spin cycle , you can not choose Water Temp
Delay	D "Delay" button <ul style="list-style-type: none">■ Push the Delay button and the display will show the remaining time for the cycle to finish (in hours).The indicator flashes to indicate that the delay function is operating.■ Delay start can be set for 2-12hr operation.■ <i>NOTE: The delay time displays the number of hours until the selected wash program will finish (you need deduct wash time from this delay time to calculate when the wash will start).</i>

Operation and Wash Cycles

1 Press the “” button to switch power on/off

2 Press the “Cycle” button to select automatic cycles

After the power is turned on, the default is Cotton cycle. To select other fully-auto cycles, press the “Cycle” button until the corresponding indicator is illuminated. For example, when you want to wash lightly soiled clothes quickly, use a Express cycle.

3 Press the “” button to change the water level

- All of the cycles except Drum clean , Rinse & spin and spin cycles have fuzzy function and the water level can be adjusted according to the texture and quantity of clothing. After the detection is completed, the water level is set automatically.
- When the washing machine is working, the water level cannot be changed. It is necessary to press the "Start/Pause" button before pressing the water level. Press the button to reset the water level and press the Start/Stop button to start running.

4 Press the “” button to change the water temp

- Set the wash temperature in accordance to the requirements of each load.

5 Press the “Delay” button to select delay wash

When the power is turned on, the washing machine Delay procedure is automatically set to non-startup state.

The laundry process will begin immediately after pressing the Start/Pause button.

Operating Method of Delay Procedure

- Before setting the required delay time, first set up the program and other options, and then press the Delay button.
- The program LED will be turned off and the reservation indicator will be turned on.
- During the Delay process, press the "Delay" button, and display the appointment time at the end of the cycle.
- First selectable delay is + 2hours. Increasing in 1 hour increments - Maximum selectable is +12hours.
- Reservation time is the end of the cycle.



The wash will finish
in about 10 hours

Operation and Wash Cycles

6 Press the “  ” button to start the cycle

Cycle completed

When the machine has completed the selected/current wash cycle an audible alarm will sound and the machine will switch off automatically.

Note:

- Name of program for energy efficiency labelling used in warm wash tests - Eco, Water Level High, Water Temp Warm - is recommended for washing a normally soiled cotton load at rated capacity.
The rated capacity of HWT60AA1: 6kg
The rated capacity of HWT75AA1: 7.5kg
- Please use low suds/high efficiency detergent.

This washer has a 2-step water fill to achieve the required water level and temperature for the best cleaning result.

First Fill - Once options and cycle are selected and the Start/Pause Button is pressed, both hot and cold water will flow into the inner tub. The warm water temperature helps to dissolve detergent quickly. The washing operation starts at the end of the hot water fill and is followed by a 5-minute (approximately) soak-agitation session to help the detergent mix completely with the laundry.

Second Fill - The second fill is in order to reach the selected water level and make the clothes completely soaked in water to achieve a better wash effect.

Cleaning and Maintenance

Maintenance

- Remove the power plug before carrying out any cleaning or maintenance.
- Clean the lint filter(s) and detergent box after each wash, otherwise it may influence you using the machine.

Clean the detergent box and set it on the control panel seat.

(Noted: Only HWT75AA1 model has a detergent box)

1. The method of dismantling: Tilt upward pull out and gently.
2. The method of cleaning: Use a brush and duster cloth to clean it, then flush it with water.
3. Installation method: tilt upward and push in.

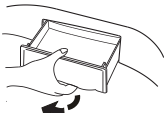

Remove

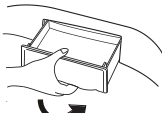

Install

The filter at the water inlet valve may become blocked by impurities in the water supply. Clean it with a plastic bristled brush every two months.

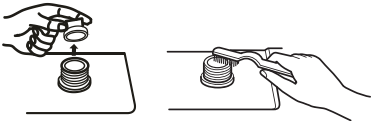

■ Both lint filters must be used during washing.

■ Must be cleaned after each use.

Remove and reinstall the lint filter as follows:

1. Push down spring piece of the top lint filter and pull out to remove (figure1)
2. Pull the back of the lint filter to open (figure2)
3. Remove any lint in the lint filter.
4. Push the back of the lint filter back into the front cover.
5. Put the lint filter into filter housing, and make it tight.
6. Make sure the lint filter is well installed, or it can influence performance of the washer.

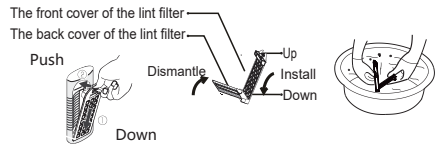
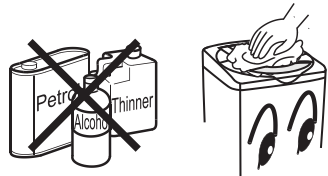

Figure 1

Figure 2

If the cabinet is dirty, wipe it with a damp cloth

- Do not wash directly with water.
- Wipe with a neutral detergent (please check directions on detergent bottle first).
- Do not wipe machine with thinners, petrol, alcohol or other hash solvents.



1. After the washing cycle has finished, turn off the water faucet.
2. Do not store water in the washing machine for a long period without completing a wash cycle. Drain the water completely after each wash.
3. Wipe up any drops of water on the surface of the machine and inside the tub. Leave the lid open for about 1 hour after each wash to evaporate any residual water.



Trouble-shooting

If there is a fault or the machine does not operate correctly, remove the power plug before checking the machine. Using diagnostic list below, please check if the machine requires a repair. If a repair is required, please contact our customer care team, do not try to fix it by yourself.

Problem		Possible causes	What to do
The machine does not drain or drains slowly. The display shows E1.		<ul style="list-style-type: none"> ■ Is the drain hose blocked? 	Remove the blockage. Push the Start/Pause button once.
The machine stops running The display shows E2.		<ul style="list-style-type: none"> ■ The top lid is not closed. 	Close the top lid. Push the Start/Pause button once.
The machine does not spin The display shows Ob.		<ul style="list-style-type: none"> ■ Has the laundry been placed unevenly in the machine? ■ Is the machine level? 	<ul style="list-style-type: none"> ■ Redistribute the load evenly. Push the Start/Pause button once. ■ Level the machine. Push the Start/Pause button once.
The display shows E4.		<ul style="list-style-type: none"> ■ Is the water tap closed or has the water supply been interrupted? ■ Is the water inlet valve blocked? ■ Is the water pressure too low? 	<ul style="list-style-type: none"> ■ Open the water tap. Push the Start/Pause button once. ■ Clean the water inlet valve then push the Start/Pause button once. ■ Use after the water pressure is normal.
The water tap leaks.		<ul style="list-style-type: none"> ■ Is the water inlet hose loose? 	<ul style="list-style-type: none"> ■ Fasten the inlet hose.
The machine does not work.	Will not wash	<ul style="list-style-type: none"> ■ Is there a power failure? ■ Is the power plug inserted tightly? ■ Has the water level reached preset position? 	<ul style="list-style-type: none"> ■ Wait for the power supply to be restored. ■ Insert the power plug tightly. ■ Wait for the water to fill to the preset level
	Will not spin	<ul style="list-style-type: none"> ■ Is the power plug inserted tightly? ■ Is the top lid closed? ■ Is the laundry distributed unevenly in the machine? 	<ul style="list-style-type: none"> ■ Insert the power plug tightly. ■ Close the top lid. ■ Redistribute the laundry. Close the top lid. Push the Start/Pause button once.
There are abnormal sounds inside the machine.		<ul style="list-style-type: none"> ■ Is the machine levelled? ■ Has the laundry been placed unevenly in the machine? ■ Are there any foreign objects inside the tub? 	<ul style="list-style-type: none"> ■ Level the machine. ■ Redistribute the load evenly. Close the top lid. ■ Remove the foreign object.



Trouble-shooting

Problem	Possible causes	What to do
The display shows FA	■ The water level sensor has failed.	■ Please contact Customer Care.
The display shows F2.	■ Overflow Error	■ Please contact Customer Care.
The display shows FC2.	■ Communication failure between display board and Power board.	■ Please contact Customer Care.

Common occurrences

Situation	Cause
■ The spinning is intermittent after it starts.	■ Redistribute the load evenly. Close the top lid.
■ Select spin program, but it does not work.	■ The program is setting the drain time, there will be a pause before the spin program starts.
■ There maybe water in the drain hose when first used.	■ These maybe water residual after performance inspection by the factory.

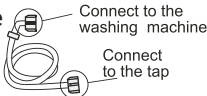
Packing list

Name	Quantity	Storage position
■ Automatic washing machine	■ One	
■ Bottom plate 	■ One	■ Between the upper cushion of the washing machine package and the upper seal of the package carton
■ User manual	■ One	■ Inside the document bag
■ Components of the water inlet hose 	■ Two	■ Inside the accessory bag
■ Screw 	■ One	■ Inside the document bag
■ Warranty Card	■ One	■ Inside the packing box
■ Drain Hose & Clamp	■ One	■ Inside the packing box
■ Drain Hose hook	■ One	■ On the drain hose

Specification

Type	TOP LOAD FULL-AUTOMATIC WASHING MACHINE	
Model	HWT60AA1	HWT75AA1
Rated voltage/frequency	220-240V/50Hz	220-240V/50Hz
Rated washing power	385W	400W
Rated spinning power	345W	370W
Net weight	32kg	40kg
Gross weight	38kg	46kg
Dimensions(mm)	W 520 D 540 H 905	W 550 D 570 H 940
Water inlet pressure	0.03MPa-1.0MPa	0.03MPa-1.0MPa
Rated Washing capacity	6kg	7.5kg