

User manual
Washing machine

HWF75AW3

Haier

NZ AU

Thank you for purchasing a Haier Product.

Please read these instructions carefully before using this appliance. The instructions contain important information which will help you get the best out of the appliance and ensure safe and proper installation, use and maintenance.

Keep this manual in a convenient place so you can always refer to it for the safe and proper use of the appliance.

If you sell the appliance, give it away, or leave it behind when you move house, make sure you also pass this manual so that the new owner can become familiar with the appliance and safety warnings.

Legend



Warning – Important Safety information



General information and tips



Environmental information

Disposal



Help protect the environment and human health. Put the packaging in applicable containers to recycle it. Help to recycle waste of electrical and electronic appliances. Do not dispose appliances marked with this symbol with the household waste. Return the product to your local recycling facility or contact your municipal office.



WARNING!

Risk of injury or suffocation!

Disconnect the appliance from the mains supply. Cut off the mains cable and dispose of it. Remove the door catch to prevent children and pets to get closed in the appliance.

1-Safety information..... 4

2-Product description..... 7

3-Control panel 8

4-Programmes 11

5-Consumption..... 12

6-Daily use 19

7-Eco-friendly washing 18

8-Care and cleaning 19

9-Troubleshooting 22

10-Installation..... 25

11-Technical data..... 29

12-Customer service..... 30

Before switching on the appliance for the first time read the following safety hints!



WARNING!

Before first use

- ▶ Make sure there is no transport damage.
- ▶ Make sure all transport bolts are removed.
- ▶ Remove all packaging and keep out of children's reach.
- ▶ Handle the appliance always with at least two persons because it is heavy.

Daily use

- ▶ This appliance is not intended for use by persons (including children) with reduced physical, sensory or mental capabilities, or lack of experience and knowledge, unless they have been given supervision or instruction concerning use of the appliance by a person responsible for their safety.
- ▶ Children should be supervised to ensure that they do not play with the appliance.
- ▶ Children shall not play with the appliance.
- ▶ Do not let children or pets come close to the appliance when the door is open.
- ▶ Store washing agents out of reach of children.
- ▶ Pull up zips, fix loose threads and take care for small items to prevent laundry from being entangled. If necessary, use an appropriate bag or net.
- ▶ Do not touch or use the appliance when barefoot or with wet or damp hands or feet.
- ▶ Do not cover or encase the appliance during operation or afterwards to allow any moisture or dampness to evaporate.
- ▶ Do not place heavy objects or sources of heat or damp on top of the appliance.
- ▶ Do not use or store flammable detergent or dry cleaning agent in close vicinity to the appliance.
- ▶ Do not use any flammable sprays in close vicinity to the appliance.
- ▶ Do not wash any garments treated with solvents in the appliance without having dried them previously in the air.

**WARNING!****Daily use**

- ▶ Do not remove or insert the plug in the presence of flammable gas.
- ▶ Do not hot wash foam rubber or sponge-like materials.
- ▶ Do not wash any laundry which is polluted with flour.
- ▶ Do not open detergent drawer during any wash cycle.
- ▶ Do not touch the door during the washing process, it gets hot.
- ▶ Do not open the door if the water level is visible over the porthole.
- ▶ Do not force the door to open. The door is fitted with a self-lock device and will open shortly after the washing procedure is ended.
- ▶ Switch off the appliance after each wash programme and before undertaking any routine maintenance and disconnect the appliance from the electrical supply to save electricity and for safety.
- ▶ Hold the plug, not the cable, when unplugging the appliance.

Maintenance / cleaning

- ▶ Make sure children are supervised if they carry out cleaning and maintenance.
- ▶ Disconnect the appliance from the electrical supply before undertaking any routine maintenance.
- ▶ Keep the lower part of the porthole clean and open door and detergent drawer if appliance is not in use to prevent odours.
- ▶ Do not use water spray or steam to clean the appliance.
- ▶ Replace a damaged supply cord only by the manufacturer, its service agent or similarly qualified persons in order to avoid a hazard.
- ▶ Do not try to repair the appliance by yourself. In case of repair please contact our customer service.

Installation

- ▶ The appliance should be placed in a well-ventilated place. Ensure a location which allows opening the door fully.
- ▶ Never install the appliance outdoors in a damp place, or in an area which may be prone to water leaks such as under or near a sink unit. In the event of a water leak cut power supply and allow the machine to dry naturally.



WARNING!

Installation

- ▶ Install or use the appliance only where the temperature is above 5 °C.
- ▶ Do not place the appliance directly on a carpet, or close to a wall or furniture.
- ▶ Do not install the appliance in direct sunlight or in the near of heat sources(e.g. stoves, heaters).
- ▶ Make sure that the electrical information on the rating plate agrees with the power supply. If it does not, contact an electrician.
- ▶ Do not use multi-plug adapters and extension cables.
- ▶ Make sure only the delivered electric cable and hose set are used.
- ▶ Make sure not to damage the electric cable and the plug. If damaged have it replaced by an electrician.
- ▶ Use a separate earthed socket for the power supply which is easy accessible after installation. The appliance must be earthed.
- ▶ Make sure the hose joints and connections are firm and there is no leakage.
- ▶ The new hose-sets supplied with the appliance are to be used and that old hose-sets should not be reused.
- ▶ The manual are suitable for 7.5kg washing machines.
The applicable water pressure of the washing machine is 0.03MPa to 1MPa.

Intended use

This appliance is intended for washing machine-washable laundry only. Anytime follow the instructions given on the label of each garment label. It is designed exclusively for domestic use inside the house. It is not intended for commercial or industrial use.

Changes or modifications to the device are not allowed. Unintended use may cause hazards and loss of all warranty and liability claims.

i Note:

Due to technical changes and different models, the illustrations in the following chapters may differ from your model.

2.1 Picture of appliance

Front (Fig. 2-1):



- | | |
|----------------------------------|-------------------|
| 1 Detergent /
Softener drawer | 4 Washer door |
| 2 Programme selector | 5 Service flap |
| 3 Panel | 6 Adjustable feet |

Rear side (Fig. 2-2):

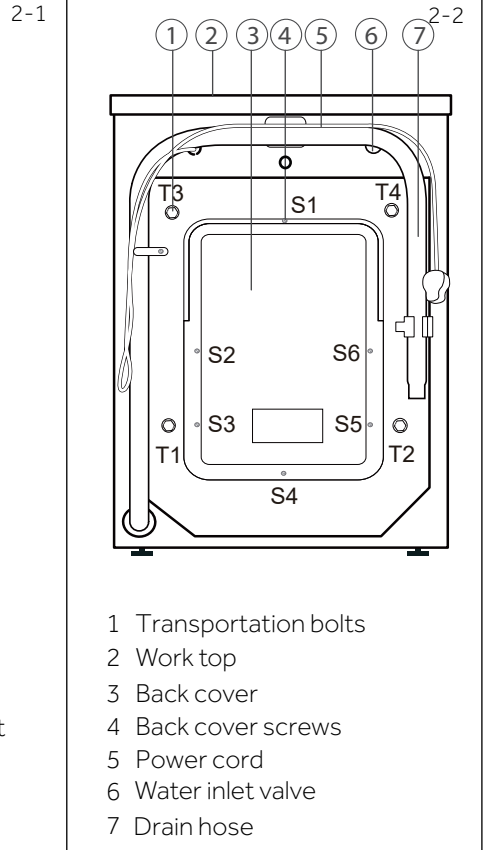

- 1 Transportation bolts
- 2 Work top
- 3 Back cover
- 4 Back cover screws
- 5 Power cord
- 6 Water inlet valve
- 7 Drain hose

2.2 Accessories

Check the accessories and literature in accordance with this list (Fig.2-3):

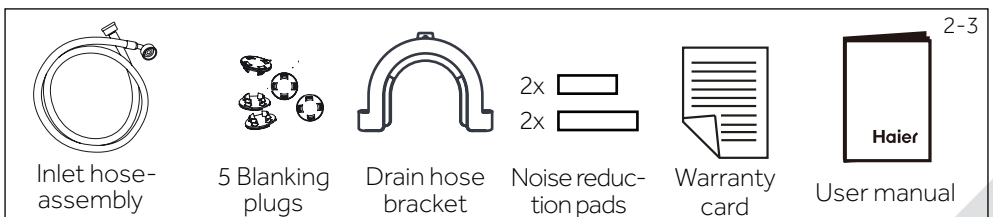

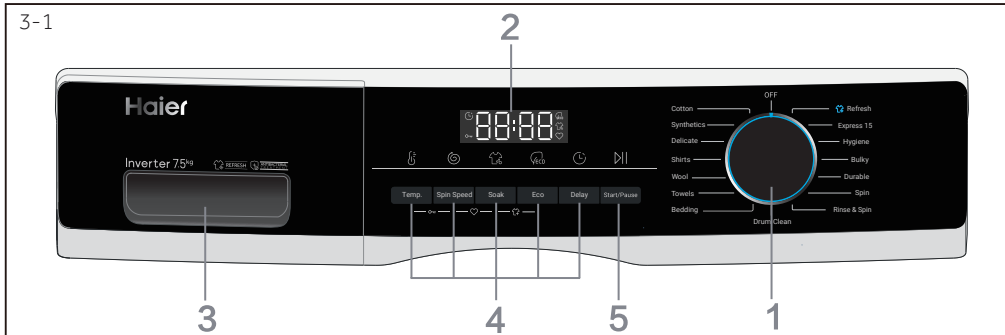

- 1 Programme selector
- 2 Display
- 3 Detergent /Softener drawer
- 4 Function buttons
- 5 "Start/Pause" button



3.1 Programme selector

By turning the knob (Fig. 3-1) one of 15 programmes can be selected.



3.2 Display

The display (Fig. 3-3) shows following information

- ▶ Temp.: Touch to select washing temperature.
- ▶ Spin Speed: Touch to select different speeds.
- ▶ Soak: Touch to select soak function.
- ▶ Eco: Touch to select energy saving mode.
- ▶ Delay: Touch to select to delay the start time of the cycle.
- ▶ Error codes and service information.
- ▶ Function buttons and "Start/Pause" button.
- ▶ Remaining completion time.

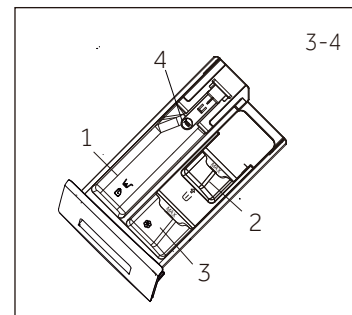

3.3 Detergent drawer

Open dispenser drawer, the following components can be seen (Fig. 3-4):

- 1: compartment for powder or liquid detergent.
- 2: compartment for laundry aid products such as powder stain removers and soaking agents.

3: compartment for softener.

4: lock tab, press it down to pull out dispenser drawer.

The recommendation on the type of detergents is suitable for the various washing temperatures, please refer to the manual of detergent (see P11).

3.4 Function buttons

The function buttons (Fig. 3-5) enable additional options in the selected programme before programme starts. The related indicators are displayed.

By switching off the appliance or setting a new programme, all options are disabled.

If a button has multiple options, the desired option can be selected by pressing the button sequentially.

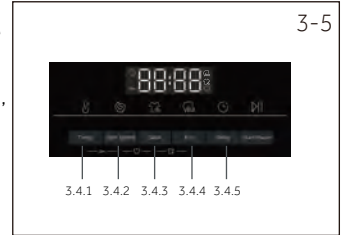

i Note: Factory settings

To get best results in each programme Haier has well defined specific default settings. If there is no special requirement default settings are recommended.

3.4.1 Function button "Temp."

Touch this button (Fig. 3-6) to change the washing temperature of the programme. If no value is selected (the display "-- °C") the water will not be heated.

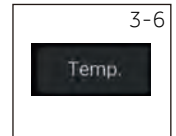

3.4.2 Function button "Spin Speed"

Touch this button (Fig. 3-7) to change the spin speed of the programme. If "0" is selected, the laundry will not spin.

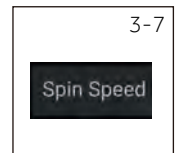

3.4.3 Function button "Soak"

Touch this button (Figure 3-8), select the depth soaking time, panel displays , and some programs "Soak" are not optional.



3.4.4 Function button "Eco"

Touch the button (Fig. 3-9) to use the Eco option to save water and energy, panel displays , and some programs "Eco" are not optional.

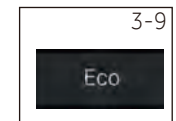

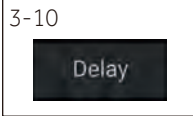

3.4.5 Function button "Delay"

Touch this button (Fig. 3-10) to increase the delay time in a regular pattern of 0:15, 0:30, 1:00, 2:00, 3:00... (the maximum range is 12h).

The delay time is the washing start time.

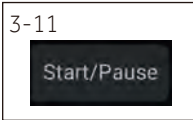

3.5 "Start/Pause" button

Touch the button (Fig. 3-11) gently to start or pause the currently displayed programme.



3.6 Key lock

Press and hold "Temp." and "Spin Speed" combination keys for three seconds, the Key lock icon (Fig. 3-12) lights up. All buttons on control panel excepting the Power buttons are disabled. Repeat the operation to release the lock.

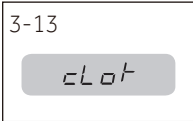

The display shows 잠금 (Fig.3-13) if a button is pressed, if a button is pressed while the key lock is activated.

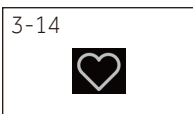

3.7 Favourite

Choose a program and the desirable modifiers, before starting the loop. Press "Spin Speed" and "Soak" (Fig. 3-14) for 3 seconds simultaneously to save personalised options for available programme, panel displays . For restoring the default parameters for all programmes please select Express 15 programme and then touch button "Soak", "Delay" for 3 seconds simultaneously, the display shows DEF (Fig. 3-15).

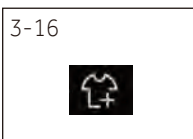

3.8 Add clothes half

Press the "Soak" and "Eco" buttons at (Fig. 3-16) the same time, the washing machine will stop running (if the water level is high, it will automatically drain to a safe height and the door lock will open). At this time, open the door to add clothes, and press the "Start/Pause" button to continue running.

● Yes, ○ Optional, / No

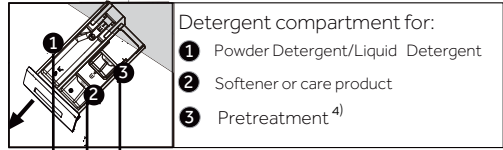

Programme	Max. load in kg	Temperature in °C ¹⁾	selectable range	Preset			Fabrics type	Preset spin speed in rpm	Soak	Eco
				1	2	3				
Cotton	7.5	* to 80	30	●	●	○	Cotton	1000	●	●
Synthetic	7.5	* to 60	30	●	●	○	Synthetic or mixed fabric	1000	●	●
Delicate	2	* to 30	30	●	●	○	Delicate laundry and silk	600	●	●
Shirts	2.5	* to 40	40	●	●	○	Shirts	1000	●	●
Wool	1	* to 40	0	●	●	○	Wool	800	●	●
Towels	7.5	* to 80	60	●	●	○	Towel	1200	●	●
Bedding	5	* to 60	30	●	●	○	Bedding of cotton or synthetic fiber	1000	●	●
Refresh ³⁾	1	/	/	/	/	/	Cotton/Synthetic	0	/	/
Express 15 ²⁾	1	* to 40	*	●	●	○	Cotton/Synthetic	1000	/	/
Hygiene	7.5	* to 80	60	●	●	○	Cotton/Synthetic	1000	●	/
Bulky	6	* to 60	30	●	●	○	Cotton/Synthetic	1000	●	●
Durable	7.5	* to 60	30	●	●	○	Cotton/Synthetic	1000	●	●
Spin	7.5	/	/	/	/	/	Non-fragile fabric	1000	/	/
Rinse & Spin	7.5	/	/	/	●	/	Non-fragile fabric	1000	/	/
Drum Clean	/	* to 80	80	/	/	/	/	/	/	/

* Water is not heated up.

- 1) Choose 80°C wash temperature only for special hygienic requirements.
- 2) Dose detergent according to load size. Note Express 15 is a low capacity cycle.
- 3) Refresh tips: Refresh care should be used for dry clothes. If the clothes are wet, dry before using this cycle. Please use soft cloth to protect the embroidery and decorations on the clothing surface in advance to avoid scratching the clothing surface. Refresh has the function of removing smell, please do not spray perfume, freshener, etc. Refresh care would work its best when used one garment at a time. Not suitable for large down jackets or bulky items.
- 4) After adding pretreatment, please reduce the amount of detergent appropriately.

The design and specifications are subject to change without notice for quality improvement purposes.

Check the energy label for energy consumption information.

The actual energy consumption may differ from the declared one according to local conditions.

The warm wash eco cycle (Cotton, 40 °C , 1200rpm) is the recommended cycle for a normally soiled load equal to the rated load capacity (7.5kg). Actual water temperature may differ from declared cycle temperature.



Note: Auto Weight

The appliance is equipped with a loading recognition. At low loading, energy, water and washing time will be reduced automatically in some programmes. The display shows "AUTO".



General information and tips:

Standard programme for the Energy and Water Labelling according to AS/NZS 2040.2

Cotton, 40 °C , 1200 rpm , others are default setting. When using standard program washing, please use 80% standard detergent.

Detergent dissolvent method: Dissolve the detergent first and pour the dissolved detergent into the machine when the main wash starts. The washing operation starts at the end of the first water filling.

6.1 Power supply

Connect the washing machine to a power supply (220V to 240V~/50Hz; Fig. 6-1). Please refer also to section INSTALLATION (see P28).

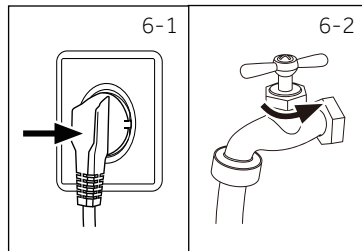

6.2 Water connection

- ▶ Before connecting check the cleanliness and clarity of the water inlet.
- ▶ Turn on the tap (Fig.6-2).



Note: Tightness

Before use check for leakage in the joints between the tap and the inlet hose by turning on the tap.

6.3 Preparing laundry

- ▶ Sort out clothes according to fabric (cotton, synthetics, wool or silk etc.) and how to dirty they are (Fig. 6-3). Pay attention to the care labelling of washing labels.
- ▶ Separate white clothes from coloured ones. Wash coloured textiles first by hand to check if they fade or run.
- ▶ Empty pockets (keys, coins, etc.) and remove harder decorative objects (e.g. brooches).
- ▶ Garments without hems, delicates and finely woven textile such as fine curtains are to be put into a wash bag to care for this delicate laundry (hand or dry cleaning would be better).
- ▶ Close zippers, velco fastener and hooks, make sure the buttons are sewn on tightly.
- ▶ Place sensitive items like laundry without firm hem, delicate underwear and small items such as socks, belts, bras, etc. in a wash bag.
- ▶ Unfold large pieces of fabric such as bed sheets, bedspreads etc.
- ▶ Turn jeans and printed, decorated or color-intensive textiles inside out; possibly wash separately.

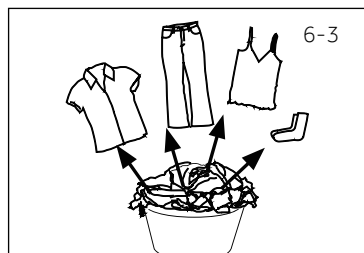

CAUTION!

Non-textile, as well as small, loose or sharp-edged items may cause malfunctions and damage of clothes and appliance.

Care chart

Washing					
	Washable up to 95°C normal process		Washable up to 60°C normal process		Washable up to 60°C mild process
	Washable up to 40°C normal process		Washable up to 40°C mild process		Washable up to 40°C very mild process
	Washable up to 30°C normal process		Washable up to 30°C mild process		Washable up to 30°C very mild process
	Wash by hand max. 40°C		Do not wash		
Bleaching					
	Any bleaching allowed		Only oxygen/ non-chlorine		Do not bleach
Drying					
	Tumble drying possible normal temperature		Tumble drying possible lower temperature		Do not tumble dry
	Line drying		Flat drying		
Ironing					
	Iron at a maximum temperature up to 200 °C		Iron at a medial temperature up to 150°C		Iron at a low temperature up to 110 °C; without steam (steam ironing may cause irreversible damage)
	Do not iron				
Professional Textile Care					
	Dry cleaning in tetrachloroethene		Dry cleaning in hydrocarbons		Do not dry clean
	Professional wet clean		Do not professional wet clean		

6.4 Loading the appliance

- ▶ Put in the laundry piece by piece.
- ▶ Don't overload. Note the different maximum load according to programmes! Rule of thumb for maximum load: Keep six inches between load and drum top.
- ▶ Close the door carefully. Make sure that no pieces of laundry are pinched.

6.5 Selecting detergent

- ▶ Washing efficiency and performance is determined by used detergent quality.
- ▶ Use only machine wash approved detergent.
- ▶ If needed use specific detergents, e.g synthetic and woolen fabric .
- ▶ See tips for countertop detergent stickers.
- ▶ Do not use dry cleaning agents such as trichloroethylene and similar products.

Choose the best detergent

Programme	Kind of detergent				
	Universal	Colour	Delicate	Special	Softener
Cotton	L/P	L/P	-	-	o
Synthetic	-	L/P	-	-	o
Delicate	-	-	L/P	L/P	o
Shirts	L/P	L/P	-	-	o
Wool	-	-	L/P	L/P	o
Towels	-	L	-	-	o
Bedding	P	L/P	-	-	o
Refresh	-	-	-	-	-
Express 15	L	L	-	-	o
Hygiene	-	-	-	-	-
Bulky	L/P	L	-	-	o
Durable	L/P	L/P	-	-	o
Spin	-	-	-	-	-
Rinse&Spin	-	-	-	-	o
Drum Clean	-	-	-	L/P	-

L = gel-/liquid detergent P = powder detergent O = optional - = no

If using liquid detergent, it is not recommended to activate the time delay.

We recommend by using:

- ▶ Laundry powder: 20°C to 80°C* (best use: 40-60°C)
- ▶ Color detergent: 20°C to 60°C (best use: 30-60°C)
- ▶ Wool/delicate detergent: 20°C to 40°C (best use:20-40°C)

* Choose 80 °C wash temperature only for special hygienic requirements.

* If you choose the water temperature 60°C or above,we would like to advise you to use less detergent.

* It is better to use less or free suds detergent powder.

6-4

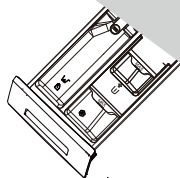

6.6 Adding detergent

1. Slide out the detergent drawer.
2. Put the required chemicals into corresponding compartments (Fig. 6-4),
3. Push back the drawer gently.

i Note:

- ▶ Remove detergent residues before next wash cycle from the detergent drawer.
- ▶ Do not overuse detergent or softener.
- ▶ Please follow the instruction on the detergent package.
- ▶ Always fill the detergent just before the beginning of the wash cycle.
- ▶ Concentrated liquid detergent should be diluted before adding.
- ▶ Do not use liquid detergent if function "Delay" is selected.
- ▶ Carefully choose the programme settings according to the care symbols on all laundry labels and according to the programme table.

6-5



6.7 Select a programme

To get the best washing results, select a programme which fits the degree of soiling and sort of laundry type.

Turn the programme knob (Fig. 6-5) to select the right programme.

i Note: Odour removal

Before first use we recommended to run programme "Cotton+80°C+600rpm" with no load and small amount of detergent in washing agent compartment (Fig. 3-4-3) or special machine cleaner to remove possibly corruptive residues.

6-6



6.8 Add individual selections

Select required options and settings (Fig. 6-6); refer to Control Panel.

6.9 Start wash programme

Touch "Start/Pause" button (Fig. 6-7) to start. Appliance operates according to present settings. Changes are only possible by cancelling the programme.



6.10 Interrupt / cancel wash programme

To interrupt a running programme press gently "Start/Pause". Press it again to resume operation.

To cancel a running programme and all its individual settings:

1. Touch "Start/Pause" button to interrupt the running programme.
2. Select a new programme and start it.

6.12 After washing

Note: Door lock

- ▶ For safety reasons the door is locked during the washing cycle. It is only possible to open the door at the end of the programme or after the programme was cancelled correctly (see description above).
- ▶ In case of high water level, high water temperature and during spinning it is not possible to open the door; Lock is displayed.

1. End is displayed at the end of the program cycle.
2. The appliance switches off automatically.
3. Remove laundry as soon as possible to prevent more wrinkling
4. Turn off the water supply.
5. Unplug the power cord.
6. Open the door to prevent formation of moisture and odours. Leave it open while not used.

Note: Standby-mode / energy-saving mode

The appliance will go into stand-by mode after 2 minutes of inactivity. The display turns off to save energy.



Environmentally responsible use

- ▶ To achieve best use of energy, water, detergent and time you should use the recommended maximum load size.
- ▶ Do not overload (hand width clearance above laundry).
- ▶ For slightly soiled laundry select the Express 15 programme.
- ▶ Apply exact dosages of each washing agent.
- ▶ Choose the lowest adequate washing temperature-modern detergents are efficiently cleaning below 60°C.
- ▶ Raise default settings only due to heavy staining.
- ▶ Select max. spinning speed if a domestic dryer is used.

8.1 Cleaning the detergent drawer

Take always care there are no detergent residues. Clean the drawer regularly (Fig. 8-1):

1. Pull out the drawer until it stops.
2. Press the release button and remove the drawer.
3. Flush the drawer with water until it is clean and insert the drawer back in the appliance.

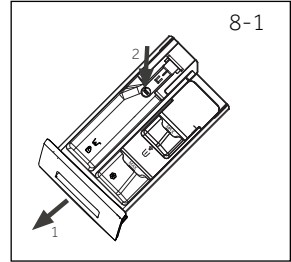

8.2 Cleaning the machine

- ▶ Unplug the machine during cleaning and maintenance
- ▶ Use a soft cloth with soap liquid to clean the machine case (Fig. 8-2) and rubber components.
- ▶ Do not use organic chemicals or corrosive solvents.



8.3 Water inlet valve and inlet valve filter

To prevent blockage of water supply by solid substances like lime clean regularly the inlet valve filter.

- ▶ Unplug the power cord and turn off the water supply.
- ▶ Unscrew the water inlet hose at the back (Fig. 8-3) of the appliance as well as on the tap.
- ▶ Flush the filters with water and a brush (Fig. 8-4).
- ▶ Insert the filter and install the inlet hose.

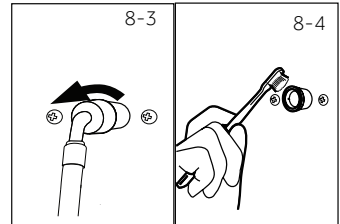

8.4 Cleaning the drum

- ▶ Remove accidentally washed items, especially metal parts such as pins, coins, etc. from the drum (Fig. 8-5) because they cause rust stains and damage.
- ▶ Use a non-chloride cleaner for removing rust stains. Observe the warning hints of the cleaning agent manufacturer.
- ▶ Do not use any hard objects or steel wool for cleaning.

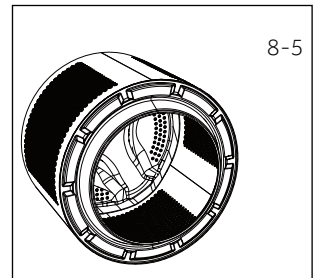

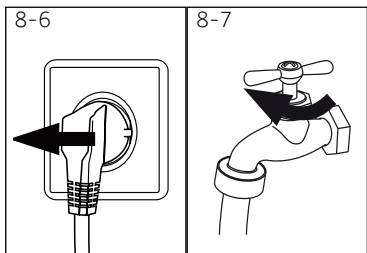

8.5 Long periods of disuse

If the appliance is left idle for a longer period:

1. Pull out the electrical plug (Fig. 8-6).
2. Turn off water supply (Fig. 8-7).
3. Open the door to prevent formation of mould and odours. Leave door open while not used.

Before next usage check carefully power cord, water inlet and drain hose. Make sure everything is properly installed and without leaks.

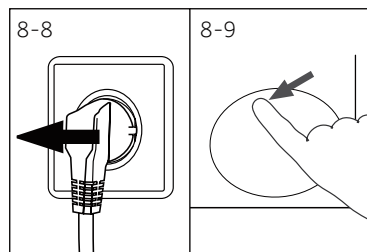

8.6 Pump filter

Clean the filter once a month and check the pump filter for instance if the appliance:

- ▶ Doesn't drain the water.
- ▶ Doesn't spin.
- ▶ Cause unusual noise while running.



WARNING!

Scalding Risk! Water in the pump filter can be very hot! Before any action please ensure water has cooled down.

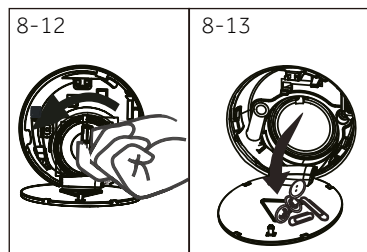
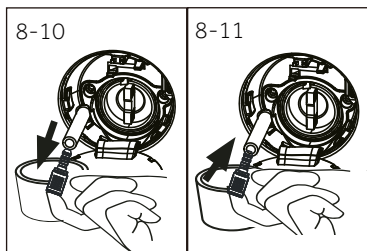

1. Turn off and unplug the machine (Fig. 8-8).
2. Push and open service flap (Fig. 8-9).
3. Provide a flat container to catch leach water (Fig. 8-10). Be prepared to catch large amounts of water.
4. Pull the drainhose out and hold its end above the container (Fig. 8-10).
5. Take the sealing plug out of the drainhose (Fig. 8-10).
6. After complete drainage close drainhose (Fig. 8-11), and push it back into the machine.
7. Unscrew and remove counter clockwise the pump filter (Fig. 8-12).
8. Remove contaminants and dirt (Fig. 8-13).

9. Clean carefully pump filter, e.g. using running water (Fig. 8-14).
10. Refix it thoroughly (Fig. 8-15).
11. Close service flap.

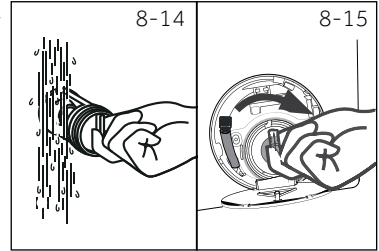

CAUTION!

- ▶ Pump filter sealing has to be clean and undamaged. If the lid is not properly tightened, water can leak.
- ▶ The filter must be in place, or it may lead to leakage.

Many occurring problems could be solved by yourself without specific expertise. In case of a problem please check all shown possibilities and follow below instructions before you contact an after sales service. See CUSTOMER SERVICE.



WARNING!

- ▶ Before maintenance, deactivate the appliance and disconnect the mains plug from the mains socket.
- ▶ Electrical equipment should be serviced only by qualified electrical experts, because improper repairs can cause considerable consequential damages.
- ▶ A damaged power cable should only be replaced by the manufacturer, its service agent or similarly qualified persons in order to avoid a hazard.

9.1 Information codes

Following codes are displayed only for information referring to the washing cycle.

Code	Message
<i>1:25</i>	The remaining wash cycle time will be 1 hour and 25 minutes.
<i>AUeD</i>	Automatic load detection is working; only in some programmes.
<i>End</i>	The washing cycle is finished. The appliance shuts off automatically.
<i>Loct</i>	Door is closed because of high water level, high water temperature or spinning cycle.
<i>clot</i>	The keylock is activated. Deactivate to make changes to the selection.
<i>Add</i>	The garment function is working.
<i>dEF</i>	Restore the default parameters for all programmes.

9.2 Troubleshooting with display code

Problem	Cause	Solution
<i>CLr</i> <i>FLEr</i>	<ul style="list-style-type: none"> • Drainage error, water is not fully drained within 6 minutes. 	<ul style="list-style-type: none"> • Clean pump filter. • Check drain hose installation.
<i>E2</i>	<ul style="list-style-type: none"> • Lock error. 	<ul style="list-style-type: none"> • Shut the door properly.
<i>E4</i>	<ul style="list-style-type: none"> • Water level has not been reached for a long time • Drain hose is self-syphoning. 	<ul style="list-style-type: none"> • Make sure that tap is fully opened and water pressure is normal. • Check drain hose installation.
<i>EB</i>	<ul style="list-style-type: none"> • Water protective level error. 	<ul style="list-style-type: none"> • Contact the After sales service.

Problem	Cause	Solution
<i>F3</i>	<ul style="list-style-type: none"> Temperature sensor error. 	<ul style="list-style-type: none"> Contact the After sales service.
<i>F4</i>	<ul style="list-style-type: none"> Heating error. 	<ul style="list-style-type: none"> Contact the After sales service.
<i>F7</i>	<ul style="list-style-type: none"> Motor error. 	<ul style="list-style-type: none"> Contact the After sales service.
<i>FR</i>	<ul style="list-style-type: none"> Water level sensor error. 	<ul style="list-style-type: none"> Contact the After sales service.
<i>FE0, FE1 or FE2</i>	<ul style="list-style-type: none"> Abnormal communication error. 	<ul style="list-style-type: none"> Contact the After sales service.

9.3 Troubleshooting without display code

Problem	Cause	Solution
Washing machine fails to operate.	<ul style="list-style-type: none"> Programme is not yet started. Door is not properly closed. Machine has not been switched on. Power failure. Key lock is activated. 	<ul style="list-style-type: none"> Check programme and start it. Close the door properly. Switch the machine on. Check power supply. Deactivate child lock.
Washing machine will not be filled with water.	<ul style="list-style-type: none"> No water. Inlet hose is kinked. Inlet hose filter is blocked. Water pressure is less than 0.03 MPa. Door is not properly closed. Water supply failure. 	<ul style="list-style-type: none"> Check water tap. Check inlet hose. Unblock inlet hose filter. Check water pressure. Close the door properly. Ensure the water supply.
Machine is draining while being filled.	<ul style="list-style-type: none"> Height of drain hose is below 80 cm. Drain hose end could reach into water. 	<ul style="list-style-type: none"> Make sure that drain hose is properly installed. Make sure the drain hose is not in water.
Drainage failure.	<ul style="list-style-type: none"> Drain hose is blocked. Pump filter is blocked. Drain hose end is higher than 100 cm above floor level. 	<ul style="list-style-type: none"> Unblock drain hose. Clean pump filter. Make sure that drain hose is properly installed.
Strong vibration while spinning.	<ul style="list-style-type: none"> Not all transportation bolts have been removed. Appliance has not being leveled. Machine load is not correct. 	<ul style="list-style-type: none"> Remove all transportation bolts. Ensure solid ground and a leveled position. Check load weight and balance.
Operation stops before completing wash cycle.	<ul style="list-style-type: none"> Water or electric failure. 	<ul style="list-style-type: none"> Check power and water supply.
Operation stops for a period of time.	<ul style="list-style-type: none"> Appliance displays error code. Problem due to load pattern. Programme performs soaking cycle. 	<ul style="list-style-type: none"> Consider display codes. Reduce or adjust load. Cancel programme and restart.

Problem	Cause	Solution
Excessive foam in drum or detergent drawer.	<ul style="list-style-type: none"> • Detergent is not appropriate. • Detergent is too concentrated. 	<ul style="list-style-type: none"> • Check detergent recommendations. • Dilute detergent.
Automatic adjustment of washing time	<ul style="list-style-type: none"> • Washing programme duration will be adjusted 	<ul style="list-style-type: none"> • This is normal and doesn't affect functionality.
Spinning fails.	<ul style="list-style-type: none"> • Unbalanced of laundry. 	<ul style="list-style-type: none"> • Redistribute load and run a spin program again.
Unsatisfactory washing result.	<ul style="list-style-type: none"> • Cycle was not selected for the soil level in the garments. • Detergent quantity was not sufficient. • Maximum load has been exceeded. • Laundry was unevenly distributed in the drum. 	<ul style="list-style-type: none"> • Select another programme. • Choose an adequate detergent and dose according to the manufacturer specifications. • Reduce loading. • Loose the laundry.
Washing powder residue are on the laundry.	<ul style="list-style-type: none"> • In soluble particles of detergent can remain as white spots on the laundry. 	<ul style="list-style-type: none"> • Avoid choosing speed up or express cycles for heavily soiled garments. • Try to brush the points from the dry laundry. • Choose another detergent. • Try adding "Soak" functionality to the cycle.
Laundry has grey patches.	<ul style="list-style-type: none"> • Caused by fats such as oils, creams or ointments. 	<ul style="list-style-type: none"> • Pretreat the laundry with a special cleaner.

i Note: Foam formation

If too much foam is sensed during spin cycle, motor stops and drain pump will be activated for 90 seconds. If that elimination of foam fails up to 3 times, programme ends with out spinning.

Should the error messages reappear even after the taken measures, switch off the appliance, disconnect the power supply and contact the customer service.

9.4 In case of power failure

The current programme and its setting will be saved. When power supply is restored operation will be resumed.

If a power failure cuts an operating wash programme door opening is mechanically block. To get out any laundry water level should not be seen through the door porthole. Danger of burns! Water level has to be lowered as described in "Pump filter". Not till then pull lever (A) beneath service flap (Fig. 9-1) until door is unlocked by a gentle click. Afterwards refix all parts.

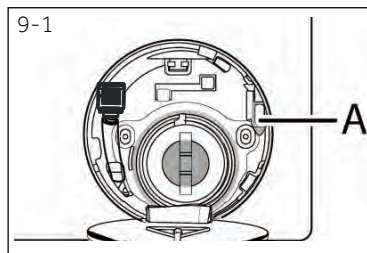

i When the washing machine in a safe state (under the water level below the window along a certain distance, barrel temperature below 55 °C, the inner barrel did not turn), may unlock the doors of the machine operation.

10.1 Preparation

- ▶ Take the appliance out of the packaging.
- ▶ Remove all packaging material including protecting film on cabinet, polystyrene base, keep them out of childrens reach. While opening the package, water drops may be seen on plastic bag and porthole. This normal phenomenon results from water tests in the factory.



Note: Packaging disposal

Keep all packaging materials out of children's reach and dispose them in an environmentally friendly manner.

10.2 OPTIONAL: Install noise reduction pads

1. When opening the shrink package, you will find four noise reduction pads. These are used for reducing noise (Fig. 10-1).
2. Lay the washing machine down to its side, porthole pointing upwards, bottom side towards operator.
3. Take out the noise reduction pads and remove the double-sided adhesive protective film; paste around the bottom ; the noise reduction pads under the washing machine cabinet as shown in Figure 3 (two longer pads in position 1 and 3, two shorter pads in position 2 and 4). Finally set the machine upright again.

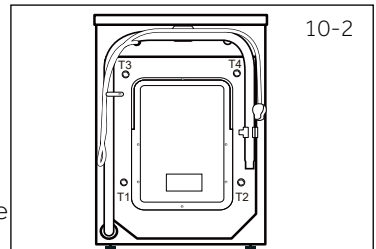
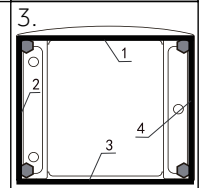
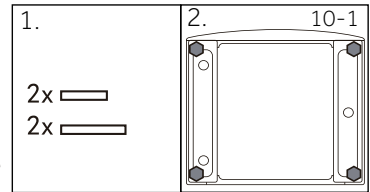

10.3 Dismantle the transportation bolts

The transport protection on the rear side is designed for clamping anti-vibration components inside the appliance during transportation to prevent inner damage. All elements (T1-T4, Fig 10-2) must be removed before use.

1. Remove all 4 bolts (T1 - T4) (Fig. 10-3).

General information and tips:

Keep the transportation bolts in a safe place for later use. If the machine is to be moved to another location, replace transportation bolts contrariwise to prevent damage.

2. Fill the transportation bolt holes with blanking plugs (Fig. 10-4).

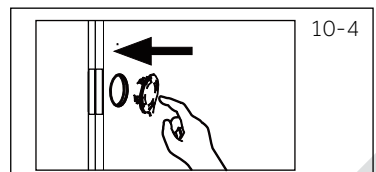
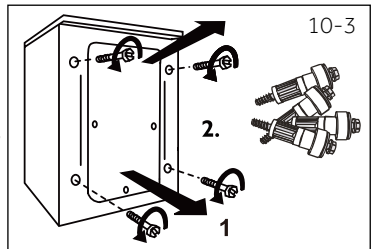

10.4 Moving the appliance

If the machine is to be moved to a distant location, replace the transportation bolts removed before installation to prevent damage: The assembly takes place in reverse order.

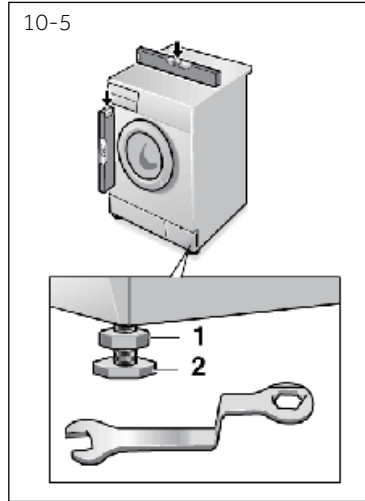

10.5 Aligning the appliance

Adjust all feet (Fig. 10-5) to achieve a complete level position. This will minimize vibrations and thus noise during use. It will also reduce wear and tear. We recommend to a spirit level for adjustment. Floor should be as stable and flat as possible.

1. Loose the locknut (1) by using a wrench.
2. Adjust the high by turning the foot (2).
3. Tighten locknut (1) against the housing.

10.6 Drain Water Connection

Fix the water drain hose properly to the piping. The hose has to reach at one point a height between 80 and 100 cm above the appliance bottom line! If possible keep always drain hose fixed to the clip at the appliance back.



WARNING!

- ▶ Use only the supplied hose set for the connection.
- ▶ Never reuse old hose sets!
- ▶ Only connect to cold water supply.
- ▶ Before connection, check whether the water is clean and clear.

Following connections are possible:

10.6.1 Drain hose to sink

- ▶ Hang the drain hose with the U-support over the edge of a sink with adequate size (Fig. 10-8).
- ▶ Protect the U-support sufficiently against slipping.

10.6.2 Drain hose to waste water connection

- ▶ The internal diameter of the stand pipe with vent-hole must be minimum 40 mm.
- ▶ Put the drain hose for 80-100 mm in the wastewater pipe.
- ▶ Attach the U-support and secure it (Fig. 10-9).

10.6.3 Drain hose to sink connection

- ▶ The junction must lie above the siphon.
- ▶ A spigot connection is usually closed by a pad (A). That must be removed to prevent any disfunction (Fig. 10-10).
- ▶ Secure the drain hose with a clamp.

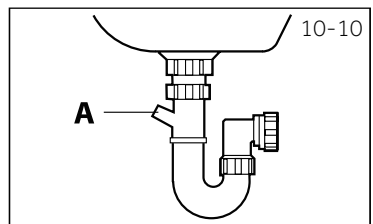
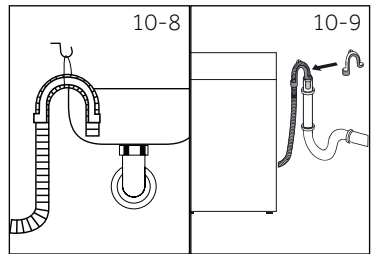

CAUTION!

- ▶ The drain hose should not be submerged in water and should be securely fixed and leak-free. If the drain hose is placed on the ground or if the pipe is at a height of less than 80 cm, the washing machine will continuously drain while being filled (self-siphoning).
- ▶ Drain hose is not to be extended. If necessary contact after sales service.

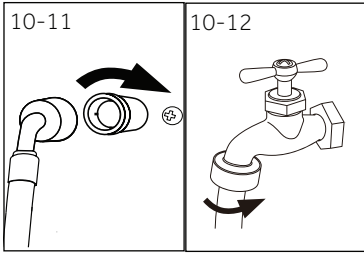

10.7 Fresh Water Connection

Make sure that the gaskets are inserted.

1. Connect the water inlet hose with the angled end to the appliance (Fig. 10-11). Tighten the screw joint by hand.
2. The other end connect to a water tap with a 3/4" thread (Fig. 10-12).

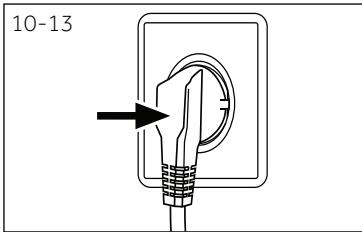

10.8 Electrical Connection

Before each connection check if:

- ▶ power supply, socket and fusing are appropriate to the rating plate.
- ▶ the power socket is earthed and no multi-plug or extension are used.
- ▶ the power plug and socket are strictly according.

Put the plug into the socket (Fig. 10-13).



WARNING!

- ▶ Ensure always that all connections (power supply, drain and fresh water hose) are firm, dry and leak free!
- ▶ Take care these parts are never to be crushed, kinked, or twisted.
- ▶ If the supply cord is damaged, it must be replaced by the service agent (see warranty card) in order to avoid a hazard.

11.1 Additional technical data

	HWF75AW3
Voltage in V	220-240 V~/50Hz
Current in A	10
Max power in W	1900
Water pressure in MPa	$0.03 \leq P \leq 1$
Net weight in kg	70

11.2 Product dimensions

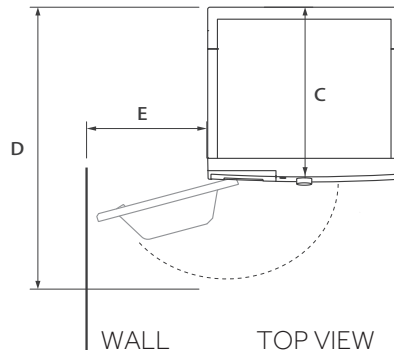
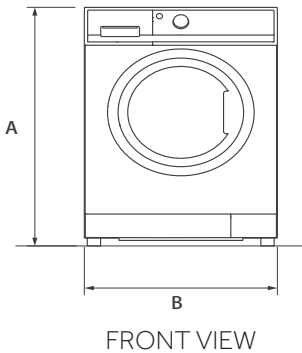

PRODUCT DIMENSIONS	HWF75AW3
A Overall height of product mm	850
B Overall width of product mm	595
C Overall depth of product (To main control board size) mm	550
D Depth of door open mm	1084
E Minimum door clearance to adjacent wall mm	260

Note: The exact height of your washer is dependent on how far the feet are extended from the base of the machine. The space where you install your washer needs to be at least 40mm wider and 20mm deeper than its dimensions.

We recommend our Haier Customer Service and the use of original spare parts.
If you have a problem with your appliance, please first check section TROUBLESHOOTING.

If you cannot find a solution there, please contact:

- ▶ your local dealer.
- ▶ the Service & Support area at www.haier.com where you can find telephone numbers and FAQs and where you can activate the service claim.

To contact our Service, ensure that you have the following data available.
The information can be found on the rating plate.

Model _____ Serial No. _____

Also check the Warranty Card supplied with the product in case of warranty.

For general business enquiries please contact our Customer Care Centre according to Warranty Card.

For more information please refer to www.haier.com.



Haier

0020507792AY