

# Wired Controller Operation & Installation Manual

YR-E17A

## CONTENT

Parts and Functions.....	1
Operation.....	6
Wired Controller Wiring Instruction.....	34

Ver: B

- Please read this operation manual before using the wired controller.
- Please keep this manual carefully and safely.

# Parts and Functions

## Interface Display





# Parts and Functions

---



## Key

---













	On/Off key.
<b>MODE</b>	Mode key: Press this key to execute mode switch.
<b>FAN</b>	Fan key: Press this key to adjust fan speed.
	Up/Down key: Press this key to adjust temperature in the main Interface and other parameter value in other interface. And the key is also used for function switching.
<b>TIME</b>	Time key: Press this key to set clock time / Timer and malfunction parameter queried.
<b>MENU</b>	Menu key: Press this key to enter function circulation. Also this key is used to confirm changes.

## Icon

---











	Clock display , parameter display
	Timer ON/OFF
	ROOM /SET temperature display

# Parts and Functions

	ROOM/SET humidity display
	Error icon
	Four-sided air deflector display ( Only valid for part of models)
	Up/Down Swing
	Left/Right Swing (Only valid for part of models)
	Set icon
	Auto mode
	Cooling mode
	Heating mode
	Fan mode
	Dry mode
	Turbo: This icon will be displayed only when turbo function is set.
	Quiet: This icon will be displayed only when quiet function is set.

# Parts and Functions

---

	Sleeping: This icon is displayed when sleeping is set, and remaining time of sleeping is displayed by <b>00:00</b> <b>OFF</b>
	Health : This icon will be displayed only when health function is set.
	HRV (Heat Reclaim Ventilation): This icon will be displayed only when HRV function is set.
	Energy Saving: This icon will be displayed only when energy saving function is set
 Static Pressure	Static Pressure: This icon will be displayed only when setting static pressure function.
	Filter Cleaning
	Child Lock: This icon will be displayed only when child lock function is set.
	Lock
	Central
	Motion Sensing (only valid for part of models)
<b>MASTER</b>	Master: This icon will be displayed only when controller is set as master controller.
<b>SLAVE</b>	Slave: This icon will be displayed only when controller is set as slave controller.

# Parts and Functions

(1) fan speed( only valid for part models)	
⠠⠨⠠⠨⠠⠨⠠⠨	Breeze Fan Speed
⠠⠨⠠⠨⠠⠨⠠⠨⠠⠨	Low Fan Speed
⠠⠨⠠⠨⠠⠨⠠⠨⠠⠨⠠⠨	Medium Fan Speed
⠠⠨⠠⠨⠠⠨⠠⠨⠠⠨⠠⠨⠠⠨	High Fan Speed
⠠⠨⠠⠨⠠⠨⠠⠨⠠⠨⠠⠨⠠⠨⠠⠨	Super Fan Speed
⠠⠨⠠⠨⠠⠨⠠⠨⠠⠨⠠⠨⠠⠨⠠⠨ AUTO	Auto Fan Speed
(2) fan speed( only valid for part models)	
⠠⠨⠠⠨⠠⠨	Seven gear
⠠⠨⠠⠨⠠⠨	Sixth gear
⠠⠨⠠⠨⠠⠨	Fifth gear
⠠⠨⠠⠨⠠⠨⠠⠨	Fourth gear
⠠⠨⠠⠨⠠⠨⠠⠨⠠⠨	Third gear
⠠⠨⠠⠨⠠⠨⠠⠨⠠⠨⠠⠨	Second gear
⠠⠨⠠⠨⠠⠨⠠⠨⠠⠨⠠⠨⠠⠨	First gear
⠠⠨⠠⠨⠠⠨⠠⠨⠠⠨⠠⠨⠠⠨⠠⠨ AUTO	Auto

# Operation

---

## Basic function description

---

Basic function	Method of operation
ON/OFF	Press the key  to switch on/off the wired controller.
Mode control	In the state of on, press the key MODE to change mode.
Adjusting temperature	In the state of on, press the key ▲ or ▼ to adjust temperature.
Adjusting fan speed	In the state of on, press the key FAN to adjust fan speed.

# Operation

---

## Initialization

---

(1) The wired controller will display all the icons after be powered on or reset, then it gets into the initializing process.

The controller will display in sequence as follows : **88:88** (the top-left corner) → **88.8** → **88** (the bottom-right corner) → **88:88** (the top-left corner), the green LED (ON/OFF key) flashes all the time until the initialization ends.

(2) If the wired controller can't communicate with the indoor unit PCB normally after powering on, the initialization will be finished in 4 minutes, and then the communication malfunction can be checked from the malfunction inquiry function.

## Backlight time

---

(1) In the state of off , when the backlight is lit up, long press TIME and ▼ keys for 5 seconds to set backlight time, the parameter value is displayed in the upper left corner. Press ▲ or ▼ key to switch parameter between 00(means backlight always on)/15S/30S/60S and confirm by pressing the key MENU.

(2) The backlight time is fixed for 15 seconds when the controller is turned off.



# Operation

---

## Note:

When controlling Fresh Air unit, the controller's main interface will not display ▲ and ▼ keys in normal state. If you need to adjust the backlight time, please press MENU key to display ▲ and ▼ keys. And then long press TIME and ▼ keys for 5 seconds to set backlight time.

## Clock

---

- (1) The controller uses 24-hour clock. The default is 12:00 when the wired controller is turned on for the first time.
- (2) When the backlight is on, long press TIME key for 5 seconds to enter clock setting function. At this time, the minute of the time and ⌚ icon are flashing in the upper left corner. You can use ▲ or ▼ key to adjust the minute value, and long press ▲ or ▼ key to speed up the adjustment. Then press TIME key to switch to hour adjustment, and use ▲ or ▼ key to adjust the hour value. Finally, you need to press MENU key to confirm the changes and return to the main interface.
- (3) In the process of time adjustment, if there is no operation for 10 seconds or press MODE / FAN key, it will quit and previous changes are invalid.
- (4) Under timer or sleeping function, clock time can't be adjusted.

# Operation



---



## Timer



---



(1) Timer function includes Timer on, Timer off and Timer on/off.



(2) Press TIME key to enter timer setting, then you can use TIME key to switch parameters, the timer function circulation is as follows:



  (ON and the hour position are flashing) →



  (ON and the minute position are flashing) →



  (OFF and the hour position are flashing) →

  (OFF and the minute position are flashing) →

  (ON and the hour position are flashing) →

  (ON and the minute position are flashing) →

  (OFF and the hour position are flashing) →

  (OFF and the minute position are flashing) →

the timer icon disappears (cancel timer function).

# Operation

---

(3) When the hour or minute position is flashing, press ▲ or ▼ key to adjust the parameter value, and long press ▲ or ▼ key to speed up the adjustment. Then you need to press MENU key to confirm the setting.

(4) The timer function will be canceled when you press TIME key multiple times until the timer icon disappears.

## Function circulation

















---

Press MENU key (if it is the 4-way/Round-way Cassette model, you need press MENU key for 5 seconds) to enter function circulation, use ▲ or ▼ key to switch between different functions.

The function circulation is as follows (functions that are not valid for some models do not participate in the circulation, please refer to the function description of the indoor unit):

# Operation

---

SET ROOM **88**% RH (Humidity setting) →  (Up/Down swing) →   
(Left/Right swing) →  (Turbo function) →  (Indoor unit quiet) →  (Outdoor unit quiet) →  (Sleeping) →   
(Health) →  (HRV) →  (Energy saving) →  (Static pressure) →  (Filter cleaning) →  (Follow) →   
(Evade) →  (Perception) → 10 (10°C heating) →  (Health airflow up) →  (Health airflow down) → CL (Self-cleaning).

When you select a function, the corresponding icon flashes, then you can use MENU key to set/cancel function or enter the corresponding function setting interface.

## Humidity setting (only valid for part of models)

Press MENU key, you will enter function circulation, humidity setting will be displayed first. Then press MENU key to enter setting interface, at this time, you can use ▲ or ▼ key to adjust humidity parameter. The parameter adjustment range is 30%~70%. Enter into automatic control by pressing ▲ when the humidity is 70% or pressing ▼ when the humidity is 30%, and “AUto” character will be displayed in the upper left corner. Adjustment accuracy is 5%. After adjustment, press MENU key to exit the setting interface.

# Operation

---

## Swing

---

(1) Press MENU key, you will enter function circulation, use ▲ or ▼ key to switch between different functions. Switch to the Up/Down swing or Left/Right swing, then press MENU key again to enter the setting of swing angle (only valid for part of models). At this time you can use ▲ or ▼ key to adjust the swing angle. After adjustment, press MENU key to exit the setting.

(2) After adjustment, if there is no operation within 10 seconds or press MODE / FAN key, it will quit swing setting interface and previous changes are valid.

### Note:



When the communication protocol which the wired controller adopts is the second version, the up/down swing and left/right swing, or only the up/down swing is alternative by dip switch SW7. (When the communication protocol is the third or first version, SW7 is invalid.)

# Operation

---

Health airflow up/down function (only valid for part of models)

---



- (1) Press MENU key, you will enter function circulation, use ▲ or ▼ key to switch between different functions. Switch to  (health airflow up) or  (health airflow down) function, then press MENU key again to set the function. When the function is successfully set, the corresponding icon will be displayed on the main interface.
- (2) Health airflow up/down function cannot be set at the same time. When the latter function is set, the former will be automatically canceled.
- (3) When health airflow up/down function is set, if you adjust the swing angle, the health airflow up/down function will be canceled.

# Operation

---



## Sleeping

---

- (1) Press MENU key, you will enter function circulation, use ▲ or ▼ key to switch between different functions. Switch to  function, the sleeping time will display by the  which is on the top-left corner. Press TIME key to enter sleeping time setting, use ▲ or ▼ key to adjust the sleeping time by 0.5h once, the range of sleeping time is from 0.5h to 72h, press MENU key to confirm.
- (2) When the sleeping time is up, the controller will turn off.
- (3) If the state of the sleeping function is on, when you switch to the sleeping function in the function circulation, pressing MENU key to turn it off.
- (4) If controller is turned off when the sleeping function is turned on, the sleeping function will be cancelled.

## Heat Reclaim Ventilation

---

- (1) Press MENU key, you will enter function circulation, use ▲ or ▼ key to switch between different functions. Switch to  function, then press MENU key again, HRV function will be turned on. If the function is turned on,  icon will be displayed in the main interface.

# Operation

---

(2) When the HRV function is turned on, if you want to turn it off, please enter function circulation and switch to  icon, then press MENU key , and the function will be turned off.

## Switch between Fahrenheit and Celsius

(1) If the current temperature is displayed in Celsius, adjust temperature in each mode to 30°C (when energy saving function is set currently, the parameter in heating mode will be the highest limit value). Then press ▲ key for 15s to switch to Fahrenheit, the interface will display 86°F (when energy saving function is set, its highest limit value of Fahrenheit will be displayed).



(2) If the current temperature is displayed in Fahrenheit, setting temperature should be adjusted to 60°F in each mode (when energy saving function is set currently, the parameter in cooling/dry mode will be the lowest limit value). Then press ▼ key for 15s to switch to Celsius, the interface will display 16°C (when energy saving function is set, its lowest limit value of Celsius will be displayed).



# Operation

---

## Energy saving

(1) Press MENU key, you will enter function circulation, use ▲ or ▼ key to switch between different functions. Switch to  function, then press MENU key again, energy saving function will be turned on. If the function is turned on,  icon will be displayed in the main interface.

When the energy saving function is set, press MENU key to enter function circulation and choose , then press MENU key to exit energy saving function.

(2) If the energy saving function is turned on, the adjustment of the setting temperature of the cooling/dry/heating mode will be limited. The energy saving default parameters are 23°C (the lowest temperature limit of cooling and dry mode) and 26°C (the highest temperature limit of heating mode).

(3) The energy saving parameters can be changed.

① In cooling mode, set temperature to 30°C, long press FAN key for 5 seconds to enter energy saving parameter of cooling/dry mode setting, the parameter will be displayed in the top-left corner. You can use ▲ or ▼ key to adjust parameter, and the parameter adjustment range is from 16 to 30. After adjustment, you need to press MENU key to confirm changes.



# Operation

---

② In heating mode, set temperature to 16°C, long press FAN key for 5 seconds to enter energy saving parameter of heating mode setting, the parameter will be displayed in the top-left corner. You can use ▲ or ▼ key to adjust parameter, and the parameter adjustment range is from 16 to 30. After adjustment, press MENU key to confirm changes.

## Filter Cleaning

---

When filter cleaning icon  is displayed, the icon will display in function circulation. Press MENU key to enter function circulation, use ▲ or ▼ key to switch between different functions. Switch to  icon, press MENU key again to cancel the display of  icon .

## 10°C heating function (only valid for part of models)

---

(1) Only in heating mode, this function is valid in function circulation.

(2) Press MENU key, you will enter function circulation, use ▲ or ▼ key to switch between different functions. When it switches to the 10°C heating function, 10°C will flash in the temperature display area. Press MENU key to confirm.

(3) In the state of the 10°C heating function, when you switch to the 10°C heating function in the function circulation, pressing MENU key to turn it off.



# Operation

---

(4) In the state of 10°C heating function, if you change modes or adjust temperature setpoint, you will exit the 10°C heating function.

## Four-sided air deflector (only valid for part of models)

---

(1) For 4-way/Round-way Cassette, the   $4 \frac{1}{3} 2$  icon and the  icon will be displayed in the main interface.



(2) Press MENU key to select the air deflector to be set (By pressing MENU key, you can switch between the air deflector 1,2,3,4 as well as the simultaneous control.), and which air deflector flashing indicates that it is selected. When selecting a certain air deflector, you can use ▲ or ▼ key to adjust its swing angle.

(3) After adjustment, you can press MODE / FAN / TIME key or wait 10 seconds to exit the settings.

# Operation

---









## Motion sensing (only valid for part of models)







(1) Motion sensing function includes  ,  and 





 (Follow): Swing direction follows people.



 (Evade): Swing direction Evades people.

 (Perception): If no one is perceived for half an hour (the time is depends on the indoor unit or the setting of move eye), the indoor unit will be off.

(2) Press MENU key, you will enter function circulation, use ▲ or ▼ key to switch between different functions. Switch to  /  /  function, then press MENU key again,  /  /  function will be turned on. If the function is turned on,  /  /  icon will be displayed in the main interface.

In the state where the  /  /  function is turned on, if you want to turn it off, please enter function circulation and switch to  /  /  icon, then press MENU key , and the function will be turned off.

(3) When the  /  function is turned on, if you adjust swing angle, the  /  function will be turned off.

(4)  /  /  functions cannot be turned on at the same time. Only one function can exist at a time.

# Operation

---

## Mode setting (only valid for part of models)

(1) When controller is turned off, and the backlight is lit up, long press MODE key for 5 seconds to enter mode setting interface. The parameter is displayed in the top-left corner, and you can use ▲ or ▼ key to switch it between 00/01/02/03/04/06/07. After adjustment, you need to press MENU key to confirm changes.

(2) The correspondence between parameters and mode combinations is as follows:

00----- [Auto] [Cooling] [Dry] [Fan] [Heating]

01----- [Heating] [Cooling] [Dry] [Fan]

02----- [Fan] [Cooling] [Dry]

03----- [Heating] [Cooling] [Dry] [Fan]

04----- [Fan] [Heating] [Cooling]

06----- [Heating] [Fan]

07----- [Heating]

(04/06/07 is valid under the third edition communication protocol)

(3) Fresh Air unit can execute mode setting, it will execute the intersection with three modes of Fresh Air unit (cooling/heating/fan mode).

Note:



This function requires indoor units support. If the indoor unit does not support it, you may not be able to set it.

# Operation

---

## Malfunction Display

(1) If there is a malfunction, the main interface will display  icon.

(2) When backlight is on, long press TIME key for 10 seconds to enter malfunction display interface. The malfunction code is displayed in the top-left corner, and the left side of the colon is the current malfunction, and the right side of the colon is the historical malfunction. And you can also press TIME key to view more historical malfunction information. The lower right corner shows the unit number, you can use  or  key to switch it (if the controller controls multiple units).

(3) In the state of viewing malfunction, long press TIME key for 10 seconds to clear the current malfunction and a historical malfunction.

(4) If there is no malfunction, it will display “- -”.

# Operation

---

## Parameter inquiry

(1) Keep pressing MENU key for 5 seconds (if it is the 4-way/ Round-way Cassette model, the time is 10 seconds) to enter parameter inquiry interface. The parameter value is displayed in the upper left corner, and middle area displays parameter type (use ▲ or ▼ key to switch it), and the unit number is displayed in the lower right corner ( use TIME key to switch it).

(2)

Type	meaning	Parameter format
A	Indoor sensor Tai temperature	Decimal
b	Indoor sensor Tc1temperature	Decimal
C	Indoor sensor Tc2 temperature	Decimal
d	Indoor unit PMV opening/2	Decimal
E	Indoor unit address	Hexadecimal
F	Indoor unit central address	Hexadecimal

## Unit number setting

(1) Long press MENU key for 10 seconds (if it is the 4-way/ Round-way Cassette model, the time is 15 seconds) to enter unit number setting interface. The upper left corner displays the central address, and middle area displays communication address, and the unit number is displayed in the lower right corner.

# Operation

---

(2) If the communication address flashes, you can change it with ▲ or ▼ key, and the adjustment range is 0~3F. After adjustment, you need to press MENU key to confirm changes. If the communication address is static displayed, it cannot be changed.

## Child lock

---

(1) Press ▼ and MENU keys for 5 seconds to set / cancel child lock. If child lock function is set,  icon will be displayed in the main interface. In the state of child lock, all keys are not available.

(2) When controlling Fresh Air unit, the controller's main interface will not display ▲ and ▼ keys in normal state. If you want to set child lock function, please press area of ▼ key first, and then press MENU key together for 5 seconds to set / cancel child lock.

## Static Pressure (only valid for part of models)

---

(1) When the controller is turned on, press FAN and MENU keys for 5 seconds to enter static pressure interface. The parameter of static pressure is displayed in the upper left corner. And you can use ▲ or ▼ key to adjust it. After adjustment, you need press MENU key to confirm changes. The unit number is displayed in the lower right corner.



# Operation

---

- (2) The slave controller cannot set the static pressure function.
- (3) You can also use this function by function circulation.

## Self-cleaning

Note: Only valid for the units with self-cleaning function.

- (1) Press MENU key, you will enter function circulation, use ▲ or ▼ key to switch between different functions. When it switches to the “CL” function, “CL” will flash in the temperature area. Press MENU key to confirm, and the static display of “CL” indicates that the function is turned on.
  - (2) If the state of the “CL” function is on, when you switch to the “CL” function in the function circulation, pressing MENU key to turn it off.
  - (3) When the “CL” function is set, if you switch modes or switch ON/OFF, the “CL” function will be exit.
  - (4) If you set timer or sleeping function, “CL” function does not participate in the function circulation.
- If “CL” function is turned on, timer and sleeping cannot be set.

# Operation

---

## Outdoor unit quiet

---

(1) Press MENU key, you will enter function circulation, use ▲ or ▼ key to switch between different functions. When it switches to the outdoor unit quiet function, “OUT” will display in the temperature area and  icon flashes. The time parameter of the function on/off is displayed in the upper left corner. You can use TIME key to switch between “OFF → Hours of turn-on time → Minutes of turn-on time → Hours of turn-off time → Minutes of turn-off time → OFF”, use ▲ or ▼ key to adjust parameters. After adjustment, you need to press MENU key to confirm changes.

(2) When the turn-on time you set is up, the outdoor unit quiet is turned on and  icon will display in the main interface. When the turn-off time you set is up, the outdoor unit quiet is turned off.

(3) If you want to cancel this function, you can use the TIME key to switch to “OFF”, then press the MENU key to confirm.

# Operation

---

## Low temperature dehumidification

(1) Long press MENU and ▲ keys for 5 seconds to enter advanced settings. The unit number is displayed in the lower right corner. Parameter is displayed in the upper left corner. middle area displays function code. Press ▲ or ▼ key to switch to A38, and then press MENU key to enter parameter adjustment, use ▲ or ▼ key to adjust parameter to 1 (turn on low temperature dehumidification), then press MENU key to confirm change.

At this time, you can exit the advanced settings by pressing MODE key.

(2) After the low temperature dehumidification function is turned on, the range of setting temperature in dry mode is 10°C~30°C.

(3) If you want to cancel this function, please change the parameter of A38 to 0, then the range of setting temperature in dry mode is 16°C~30°C.



# Operation

---

## Light strip function (only valid for part of models)

- (1) Long press FAN key for 3 seconds to turn on light strip, the middle area briefly displays “PP” to indicate that the function is set.
- (2) If the function is turned on, long press FAN key for 3 seconds to turn off light strip, the middle area briefly displays “CC” to indicate that the function is off.

## Communication with central controller

- (1) After the controller receives the command from the centralized controller. It displays the  icon. At this time, all the keys except the ON/OFF key are invalid.
- (2) After the controller receives the lock command, it displays the  icon. At this time, all keys are invalid.
- (3) In central or lock state, backlight is valid, press any keys to wake up screen.

# Operation

---

## Temperature compensation

- (1) This function is used to compensate for ambient temperature. In the state of off, and the backlight is lit up, long press FAN key for 5 seconds to enter temperature compensation interface. You can adjust the parameters with ▲ or ▼ key. After adjustment, you need to press MENU key to confirm change.
- (2) When it is Celsius, the range of parameter adjustment is -4 ~ 4. When it is Fahrenheit, the range of parameter adjustment is -8 ~ 8.
- (3) This function is valid only during collecting ambient temperature of wired controller.

## Forced Cooling/Heating

- (1) After controller is in cooling mode and is turned off, long press ON/OFF key for 10 seconds to enter forced cooling function. At this time, controller will be turned on, and “LL” flashes in the middle area to indicate that the forced cooling function is turned on.
- (2) After controller is in heating mode and is turned off, long press ON/OFF key for 10 seconds to enter forced heating function. At this time, controller will be turned on, and “HH” flashes in the middle area to indicate that the forced heating function is turned on.

# Operation

---

(3) All keys are invalid except ON/OFF key under forced cooling/heating mode.

(4) when the forced cooling/heating is set, press ON/OFF key to exit this function.

## dFg ( Only valid for part of models)

(1) Setting method:

Press MENU key, you will enter function circulation, use ▲ or ▼ key to switch between different functions. When it switch to the dFg icon and off icon flashes. press MENU key to change, meanwhile return to the main interface.

(2) Cancellation method:

Press MENU key, you will enter function circulation, use ▲ or ▼ key to switch between different functions. When it switch to the dFg icon and on icon flashes. press MENU key to change, meanwhile return to the main interface.

# Operation

---

## VIP ( Only valid for part of models)

- (1) Setting method: Keep pressing the MENU key + ▲ key for 5 seconds to enter the advanced settings, the unit number is displayed in the lower right corner, and the decimal display area of the temperature flashes to display the function classification. Switch to H by clicking the FAN key. The function code is displayed in the integer area of the temperature zone. At this time, press ▲ or ▼ keys to switch function code to 05. Then press the MENU key to confirm, 05 in the temperature integer area is displayed statically, and the specific information in the clock display area is flashing. Pressing ▲ or ▼ keys to switch the parameters, and pressing the MENU key to confirm.
- (2) In the clock display area, 1 means the local VIP is turned on, and 0 means the local VIP is turned off;
- (3) If VIP is not set in the external machine system, any line controller of internal machine can be set with VIP function; if the external machine system has set VIP function, only the VIP machine can be set up VIP on or off.
- (4) After setting VIP function, if the internal machine is sated VIP function, the main interface will display the characters "VIP"; if it is a non-VIP internal machine, and when the mode of internal machine is different from the VIP internal machine, the controller will display the "Mode conflict" icon.

# Operation

---

(5) When switching between VIP and non-VIP, you need to exit the current Settings and enter again.

## Difference between the function of the Master wired controller and Slave wired controller

---

Comparison item	Master wired controller	Slave wired controller
Function	All functions are available	Only the following operations can be performed: (1) ON/OFF, Mode, Fan speed, Temperature setting, Swing, Energy saving, Clock function are available. (2) parameter inquiry and malfunction inquiry



# Operation

---

## Dip switch

---

DIP switch 2	ON/ OFF station	Function	Default setting
Sw1	ON	Slave wired controller	OFF
	OFF	Master wired controller	
Sw2	ON	Display ambient temperature	OFF
	OFF	Not display ambient temperature	
Sw3	ON	Collect ambient temperature from PCB of indoor unit	OFF
	OFF	Collect ambient temperature from wired controller	
Sw4	ON	Non-volatile memory invalid	OFF
	OFF	Non-volatile memory valid	
Sw5	ON	Old protocol	OFF
	OFF	Self-adaption	
Sw6	ON	Reserved	OFF
	OFF	Reserved	
Sw7	ON	Model with Up/Down and Left/Right swing	OFF
	OFF	Model with Up/Down swing	
Sw8	ON	Fresh Air unit	OFF
	OFF	Common unit	

# Operation

---

DIP switch 1	ON/ OFF station	Function	Default setting
Sw1	ON	Reserved	OFF
	OFF	Reserved	
Sw2	ON	Not display ambient humidity	OFF
	OFF	Display ambient humidity	
Sw3	ON	Reserved	OFF
	OFF	Reserved	
Sw4	ON	Reserved	OFF
	OFF	Reserved	

# Wired Controller Wiring Instruction

## Wiring Connections of Wire Controller

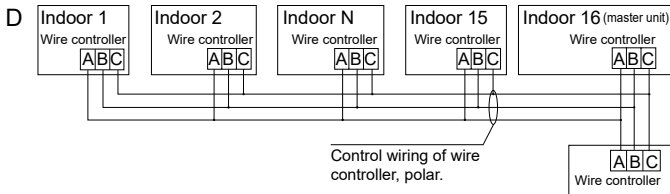
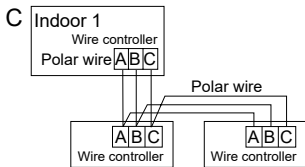
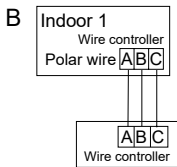
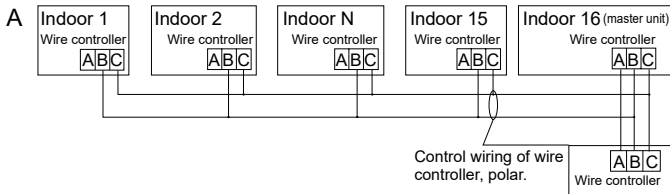

### Notice:

For wired controller connection, please do follow the corresponding indoor unit installation manual's instruction.

# Wired Controller Wiring Instruction

There are four methods to connect wired controller to the indoor units:

1. Group control shown as Figure A and D: One wired controller can control up to 16 indoor units. 3 pieces of polar wire must be used to connect the wired controller and the master unit (the indoor unit connected with wire controller directly). And other units connect to the master unit through 2 pieces or 3 pieces of polar wire depending on the indoor units, please do follow the corresponding indoor unit installation manual's instruction.
2. Individual control as shown Figure B: One wired controller controls one indoor unit, and the indoor unit connects to the wired controller through 3 pieces of polar wire.
3. Two wired controllers control one indoor unit as shown Figure C. Either one of wired controllers can be set as the master wired controller and the other as the slave wired controller. The connection between Master and slave wired controllers as well as wired controllers connecting to indoor units all requires the 3 pieces of polar wire.

# Wired Controller Wiring Instruction

## Communication wiring

Communication wiring length (m/ft)	Dimensions of wiring
< 100m/328ft	0.3mm <sup>2</sup> x3-core shielded wire (22AWG,3wire)
≥100m/328ft and <200m/656ft	0.5mm <sup>2</sup> x3-core shielded wire (20AWG,3wire)
≥200m/656ft and <300m/984ft	0.75mm <sup>2</sup> x3-core shielded wire (18AWG,3wire)

### Note:

- One side of the shielded sheet of communication wire must be earthed.
- The total length of communication wire cannot exceed 300 meters.

# Wired Controller Wiring Instruction

## Controller Installation

1. First, put communication wire through the hole in the back cover.

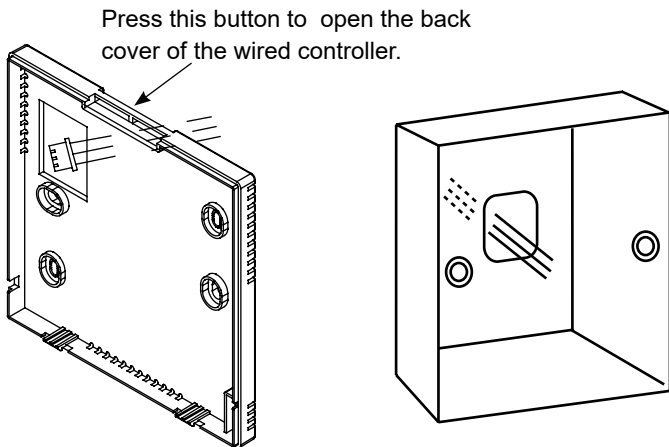

2. Fix back cover to the holder. After that, connect communication wire to CON1 port of wired controller. Finally put the front cover of wired controller to back cover to complete the installation.

# Wired Controller Wiring Instruction

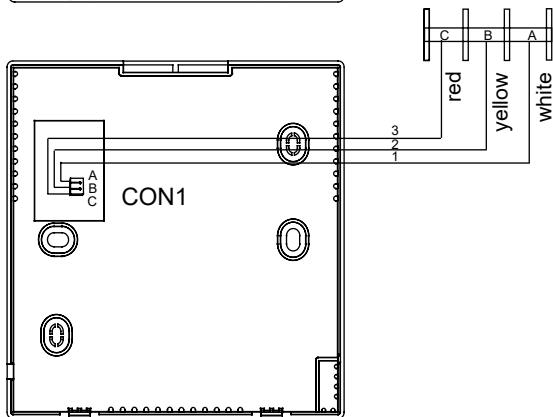
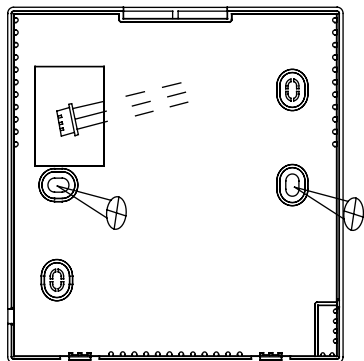

Qingdao Haier Air Conditioner Electric Co.,Ltd.

Haier Industrial Park,Qianwangang Road,Eco-Tech  
Development Zone,Qingdao 266555,Shandong,P.R.C.