

CASSETTE TYPE AIR CONDITIONER OPERATION MANUAL AND INSTALLATION MANUAL



AB09CS2ERA
AB12CS2ERA(S)
AB18CS2ERA(S)



AB24ES1ERA(S)

Contents

Cautions	3
Parts and Functions	6
Troubleshooting	10
Customer Need-to-know	12
Maintenance	12
Installation Procedure	14

No. 0150517644

- Please read this manual carefully before installation.
Keep this operation manual for future reference.

Haier

Haier Industrial Park, Qianwangang Road, Eco-Tech Development Zone, Qingdao 266555, Shandong, P.R.C.

DISPOSAL REQUIREMENTS:



Your air conditioning product is marked with this symbol. This means that electrical and electronic products shall not be mixed with unsorted household waste. Do not try to dismantle the system yourself: the dismantling of the air

conditioning system, treatment of the refrigerant, of oil and of other part must be done by a qualified installer in accordance with relevant local and national legislation. Air conditioners must be treated at a specialized treatment facility for reuse, recycling and recovery. By ensuring this product is disposed of correctly, you will help to prevent potential negative consequences for the environment and human health. Please contact the installer or local authority for more information. Battery must be removed from the remote controller and disposed of separately in accordance with relevant local and national legislation.

IMPORTANT INFORMATION REGARDING THE REFRIGERANT USED

Contains fluorinated greenhouse gases covered by the Kyoto Protocol

R410A	1=	<input type="text"/>	kg
	2=	<input type="text"/>	kg
	1+2=	<input type="text"/>	kg

F E

This product contains fluorinated greenhouse gases covered by the Kyoto Protocol. Do not vent into the atmosphere.

Refrigerant type: R410A

GWP* value: 1975

GWP = global warming potential

Please fill in with indelible ink,

- 1 the factory refrigerant charge of the product
- 2 the additional refrigerant amount charged in the field and
- 1+2 the total refrigerant charge

on the refrigerant charge label supplied with the product. The filled out label must be adhered in the proximity of the product charging port (e.g. onto the inside of the stop valve cover).

A contains fluorinated greenhouse gases covered by the Kyoto Protocol

B factory refrigerant charge of the product: see unit name plate

C additional refrigerant amount charged in the field

D total refrigerant charge

E outdoor unit

F refrigerant cylinder and manifold for charging

⚠ WARNING

If the supply cord is damaged, it must be replaced by the manufacturer, its service agent or similarly qualified persons in order to avoid a hazard.

This appliance is not intended for use by persons (including children) with reduced physical, sensory or mental capabilities, or lack of experience and knowledge, unless they have been given supervision or instruction concerning use of the appliance by a person responsible for their safety.

Children should be supervised to ensure that they do not play with the appliance.

This appliance can be used by children aged from 8 years and above and persons with reduced physical, sensory or mental capabilities or lack of experience and knowledge if they have been given supervision or instruction concerning use of the appliance in a safe way and understand the hazards involved. Children shall not play with the appliance. Cleaning and user maintenance shall not be made by children without supervision.

The appliances are not intended to be operated by means of an external timer or separate remote-control system.

Keep the appliance and its cord out of reach of children less than 8 years.

The A-weighted sound pressure level is below 70 dB.

This appliance is intended to be used by expert or trained users in shops, in light industry and on farms, or for commercial use by lay persons

The power cable should be H05RN-F 3G 4.0mm².

Air conditioner working temperature: cooling 10~46 degree, heating -15~24 degree.

Cautions

Disposal of the old air conditioner

Before disposing an old air conditioner that goes out of use, please make sure it's inoperative and safe. Unplug the air conditioner in order to avoid the risk of child entrapment.

It must be noticed that air conditioner system contains refrigerants, which require specialized waste disposal. The valuable materials contained in an air conditioner can be recycled. Contact your local waste disposal center for proper disposal of an old air conditioner and contact your local authority or your dealer if you have any question. Please ensure that the pipework of your air conditioner does not get damaged prior to being picked up by the relevant waste disposal center, and contribute to environmental awareness by insisting on an appropriate, anti-pollution method of disposal.

Disposal of the packaging of your new air conditioner

All the packaging materials employed in the package of your new air conditioner may be disposed without any danger to the environment.

The cardboard box may be broken or cut into smaller pieces and given to a waste paper disposal service. The wrapping bag made of polyethylene and the polyethylene foam pads contain no fluorochloric hydrocarbon.

All these valuable materials may be taken to a waste collecting center and used again after adequate recycling.

Consult your local authorities for the name and address of the waste materials collecting centers and waste paper disposal services nearest to your house.

Safety Instructions and Warnings

Before starting the air conditioner, read the information given in the User's Guide carefully. The User's Guide contains very important observations relating to the assembly, operation and maintenance of the air conditioner.

The manufacturer does not accept responsibility for any damages that may arise due to non-observation of the following instruction.

- Damaged air conditioners are not to be put into operation. In case of doubt, consult your supplier.
- Use of the air conditioner is to be carried out in strict compliance with the relative instructions set forth in the User's Guide.
- Installation shall be done by professional people. Don't install unit by yourself.
- For the purpose of safety, the air conditioner must be properly grounded in accordance with specifications.
- Always remember to unplug the air conditioner before opening inlet grill. Always grip plug firmly and pull straight out from the outlet.
- All electrical repairs must be carried out by qualified electricians. Inadequate repairs may result in a major source of danger for the user of the air conditioner.
- Do not damage any parts of the air conditioner that carry refrigerant by piercing or perforating the air conditioner's

tubes with sharp or pointed items, crushing or twisting any tubes, or scraping the coatings off the surfaces. If the refrigerant spurts out and gets into eyes, it may result in serious eye injuries.

- Do not obstruct or cover the ventilation grille of the air conditioner. Do not put fingers or any other things into the inlet/outlet and swing louver.
- Do not allow children to play with the air conditioner. In no case should children be allowed to sit on the outdoor unit. When the indoor unit is turned on, the PCB will test if swing motor is O.K., and then fan motor will start up. So there is a few seconds to wait.
- In cooling mode, the flaps will swing automatically to a fixed position for anti-condensating.
- This appliance is not intended for use by persons (including children) with reduced physical, sensory or mental capabilities, or lack of experience and knowledge, unless they have been given supervision or instruction concerning use of the appliance by a person responsible for their safety.
- Children should be supervised to ensure that they do not play with the appliance.

Specifications

The refrigerating circuit is leak-proof.

For all the models in this manual, the all-pole disconnection connection method should be applied in the power supply. Such means for disconnection must be incorporated in the fixed wiring.

Cooling	Indoor temperature	max. DB/WB min. DB/WB	32/23°C 18/14°C
	Outdoor temperature	max. DB/WB min. DB/WB	46/26°C 10/6°C
Heating	Indoor temperature	max. DB/WB min. DB/WB	27°C 15°C
	Outdoor temperature	max. DB/WB min. DB/WB	24/18°C -15°C

If the supply cord is damaged, it must be replaced by the manufacturer or its service agent or a similar qualified person. If the fuse on PC board is broken please change it with the type of T 3.15A /250VAC.

The wiring method should be in line with the local wiring standard.

The waste battery shall be disposed properly.

The indoor unit installation height is at least 2.5m.

The circuit and the power switch should be installed in a conveniently reachable place for user.

Cautions

Carefully read the following information in order to operate the air conditioner correctly.

Below are listed three kinds of Safety Cautions and Suggestions.

⚠ WARNING: Incorrect operations may result in severe consequences of death or serious injuries.

⚠ CAUTION: Incorrect operations may result in injuries or machine damages; in some cases may cause serious consequences.

⚠ INSTRUCTIONS: These information can ensure the correct operation of the machine.

Symbols used in the illustrations

⊘: Indicates an action that must be avoided.

⚠: Indicates that important instructions must be followed.







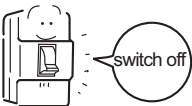

⚡: Indicates a part which must be grounded.

⚡: Beware of electric shock (This symbol is displayed on the main unit label.)

After reading this handbook, hand it over to those who will be using the unit.







The user of the unit should keep this manual at hand and make it available to those who will be performing repairs or relocating the unit. Also, make it available to the new user when the user changes hands.





Be sure to conform with the following important Safety Cautions.

⚠ WARNING	
<ul style="list-style-type: none"> • If any abnormal phenomena is found (e. g. smell of firing), please cut off the power supply immediately, and contact the dealer to find out the handling method. In such case, to continue using the conditioner will damage the conditioner, and may cause electrical shock or fire hazard. 	<ul style="list-style-type: none"> • When need maintenance and repairment, call dealer to handle it. Incorrect maintenance and repairment may cause water leak, electrical shock and fire hazard. 
<ul style="list-style-type: none"> • Don't blow the human body with the cooling air too long, and don't let the room temperature decrease too low either. Otherwise the one will feel unpleasant or harm ones' health. 	<ul style="list-style-type: none"> • Don't put fingers or any other things into the inlet/outlet and swing louver while the conditioner is in operation. Because the highspeed fan is very dangerous and may cause injuries. 
<ul style="list-style-type: none"> • Call the dealer to take measures to prevent the refrigerant from leaking. If conditioner is installed in a small room be sure to take every measure in order to prevent suffocation accident even in case of refrigerant leakage. 	<ul style="list-style-type: none"> • Please let the dealer be responsible for installing the conditioner. Incorrect installation may cause water leak, electrical shock and fire hazard. • When conditioner is deinstalled or reinstalled dealer should be responsible for them. Incorrect installation may cause water leaking, electrical shock and fire hazard.
⚠ CAUTION	
<ul style="list-style-type: none"> • Conditioner should not be used for any other purpose other than airconditioning. Don't use air-conditioner for any other special purposes, e.g. the preservation and protection of food, animals, plants, precision apparatus as well as work of art, otherwise the qualities of these stuffs may be damaged. 	<ul style="list-style-type: none"> • When air-conditioner is co-used with other heat-radiator the frequent replacement of room atmosphere should be required. Inefficient ventilation may cause suffocation. 
<ul style="list-style-type: none"> • Don't dismantle the outlet of the outdoor unit. The exposure of fan is very dangerous which may harm human beings. 	<ul style="list-style-type: none"> • After a long time use of air-conditioner the base should be checked for any damages. If the damaged base is not repaired, the unit may fall down and cause accidents.
<ul style="list-style-type: none"> • Don't dismantle the outlet of the outdoor unit. The exposure of fan is very dangerous which may harm human beings. 	<ul style="list-style-type: none"> • No goods or nobody is permitted to placed on or stand on outdoor unit. The falling of goods and people may cause accidents.

Cautions

⚠ CAUTION

- Don't dismantle the outlet of the outdoor unit.
The exposure of fan is very dangerous which may harm human beings. 
- Pets and plants should not be blown directly in the air flow.
Otherwise will suffer damage. 
- Don't operate the air-conditioner with damp hands.
Otherwise will be shocked. 
- Only use correctly-typed fuse.
May not use wire or any other materials replacing fuse, otherwise may cause faults or fire accidents. 
- Air-conditioner should be cleaned only after power supply is cut off to keep from shock or hurt. 
- Don't clean air-conditioner with water.
Otherwise may cause shock. 

- After a long time use of air-conditioner the base should be checked for any damages.
If the damaged base is not repaired, the unit may fall down and cause accidents. 
- No goods or nobody is permitted to placed on or stand on outdoor unit.
The falling of goods and people may cause accidents. 
- Don't place any burning unit in the air flow of air-conditioner, which may cause incomplete combustion. 
- No inflammable spray fluid should be permitted to be placed or used near to air-conditioner otherwise may cause fire accidents. 
- When use the fumigating insecticide don't open air-conditioner.
Otherwise the poisonous chemicals may settle in air-conditioner which harm the health of chemical-allergic people. 

⚠ INSTRUCTIONS:

Please ask the dealer or specialist to install, never try by the users themselves. After the installation please be sure of the following conditions.

⚠ WARNING:

Please call dealer to install the air-conditioner. Incorrect installation may cause water leaking, shock and fire hazard.

⚠ CAUTION:

- Air-conditioner can't be installed in the environment with inflammable gases because the inflammable gases near to airconditioner may cause fire hazard.
- Installed electrical-leaking circuit breaker.
It easily cause electrical shock without circuit breaker.
- Connect earthing wire.
Earthing wire should not be connected to the gas pipe, water pipe, lightning rod or phone line, incorrect earthing may cause shock.



Earthing

- Use discharge pipe correctly to ensure efficient discharge.
Incorrect pipe use may cause water leaking.

[Location]

- Air-conditioner should be located in well-vented and easily-accessible place.
- Air-conditioner should not be located in the following places:
 - (a) Places with machine oils or other oil vapours.
 - (b) Seaside with high salt content in the air.
 - (c) Near to hot spring with high content of sulfide gases.
 - (d) Area with frequent fluctuation of voltage e.g. factory, etc.
 - (e) In vehicles or ships.
 - (f) Kitchen with heavy oil vapour or humidity.
 - (g) Near to the machine emitting electric-magnetic waves.
 - (h) Places with acid, alkali vapour. TV, radio, acoustic appliances etc are at least 1 m far away to the indoor unit, outdoor unit, power supply wire, connecting wire, pipes, otherwise images may be disturbed or noises be created.

[Wiring]

Air-conditioner should be equipped with special power supply wire.

[Operating noise]

- Chose the following locations:
 - (a) Capable of supporting air-conditioner weight, don't increase operating noise and vibration.
 - (b) Hot vapour from outdoor unit outlet and operating noise don't disturb neighbour.
No obstacles around the outdoor unit outlet.

Parts and Functions

Remote controller

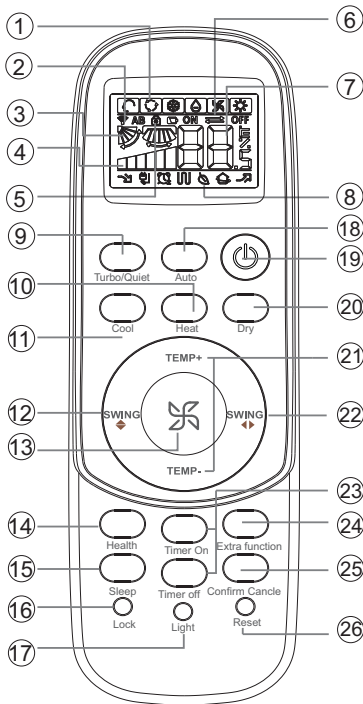

1. Mode display

Operation mode	AUTO	COOL	DRY	FAN
Remote controller				

2. Signal sending display

3. SWING display

4. FAN SPEED display

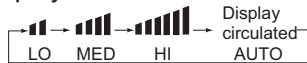

5. LOCK display

6. TIMER OFF display

TIMER ON display

7. TEMP display

8. Additional functions display

Operation mode	QUIET	SLEEP	Supplemented electrical heating	HEALTH	TURBO
Remote controller					

9. TURBO/Quiet button

10. HEAT button

11. COOL button

12. SWING UP/DOWN button

13. FAN SPEED button

14. HEALTH button

15. SLEEP button

16. LOCK button

17. LIGHT button

Control the lightening and extinguishing of the indoor LED display board.

18. Auto button

19. POWER ON/OFF button

20. DRY button

21. TEMP button

22. SWING LEFT/RIGHT button

23. TIMER OFF/ON

24. EXTRA FUNCTION button

Function: FAN → Healthy airflow → Fahrenheit/Celsius mode conversion → Low-Temperature Heating Operation Down to 50 °F(10 °C) → Fresh air A-B yard.

25. CANCEL/CONFIRM button

Function: Setting and cancel to the timer and other additional functions.

26. RESET button

When the remote controller appears abnormal, use a sharp pointed article to press this button to reset the remote.

Healthy function is not available for some units.

Base Operation

Remote controller

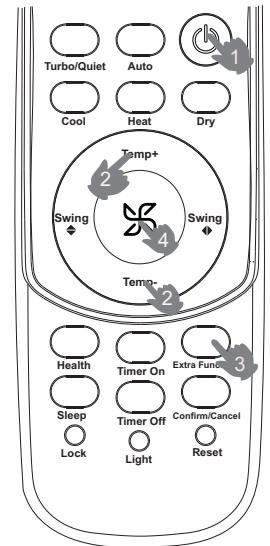

1. Unit start

Press ON/OFF on the remote controller, unit starts.

2. Select temp.setting

Press TEMP+/TEMP- button

TEMP+: Every time the button is pressed, temp.setting increase 1°F(1°C), if kept depressed, it will increase rapidly.

TEMP-: Every time the button is pressed, temp.setting decrease 1°F(1°C), if kept depressed, it will increase rapidly.

Select a desired temperature.

3. Fan function

Press button to enter additional options, when cycle display to , will flash. And then press enter to FAN function.

For each press button fan speed changes as follows:

Remote controller:



Air conditioner is running under displayed fan speed. When FAN is set to AUTO, the air conditioner automatically adjusts the fan speed according to room temperature.

Parts and Functions

Operation mode	Remote Controller	Note
AUTO		Under the mode of auto operation, air conditioner will automatically select Cool or Heat operation according to room temperature. When FAN is set to AUTO, the air conditioner automatically adjusts the fan speed according to room temperature.
COOL		Cooling only unit do not have displays and functions related with heating
DRY		In DRY mode, when room temperature becomes lower than temp. setting+2°F(2°C), unit will run intermittently at LOW speed regardless of FAN setting.
HEAT		In HEAT mode, warm air will blow out after a short period of the time due to cold-draft prevention function.
FAN		In FAN operation mode, the unit will not operate in COOL or HEAT mode but only in FAN mode, AUTO is not available in FAN mode. And temp. setting is disabled. When FAN is set to AUTO, the air conditioner automatically adjusts the fan speed according to room temperature. In FAN mode, SLEEP operation is not available.

remote controller:



Cautions:

When adjusting the flap by hand, turn off the unit. When humidity is high, condensate water might occur adjusted to left or at air outlet if all vertical louvers are right. It is advisable not to keep horizontal flap at down ward position for a long time in COOL or DRY mode, otherwise, condensate water might occur.

Note:

When restart after remote turning off, the remote controller will automatically memorize the previous set swing position.

Emergency operation and test operation

Emergency Operation:

- Use this operation only when the remote controller is defective or lost, and with function of emergency running, air conditioner can run automatically for a while.
- When the emergency operation switch is pressed, the "Pi" sound is heard once, which means the start of this operation.
- When power switch is turning on for the first time and emergency operation starts, the unit will run automatically in the following modes:

Room temperature	Designated temperature	Timer mode	Fan speed	Operation mode
Above 73°F(23°C)	79°F(26°C)	No	AUTO	COOL

- It is impossible to change the settings of temp. and fan speed, it is also not possible to operate in timer or dry mode.

Test operation switch is the same as emergency switch.

- Use this switch is the test operation when the room temperature is below 60°F(16°C), do not use it in the normal operation.
- Continue to press the test operation switch for more than 5 seconds. After you hear the "Pi" sound twice, release your finger from the switch: the cooling operation starts with the air flow speed "Hi".
- Under this operation mode, the fan motor of indoor unit will run in high speed.

Air Flow Direction Adjustment

1. Status display of air flow vertical flap.

For each press of SWING button, remote controller displays as follows:

remote controller:

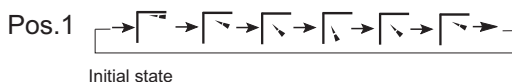

Pos.2 No initial state displayed on remote controller, the vertical flap will be fixed on the current position.

2. Left and right air flow adjustment

For each press of SWING button, remote controller displays as follows:

Comfortable SLEEP

Press SLEEP button, the remote controller will show , and then achieve to the sleep function. Press again this SLEEP button, the sleep function will be cancelled.

Operation Mode

1. In COOL, DRY mode

1 hours after SLEEP mode starts, temp. will become 2°F(1°C) higher than temp. setting. After another 1 hours, temp. rises by 2°F(1°C) further. The unit will run for further 6 hours then stops. Temp. is higher than temp. setting so that room temperature won't sleep.

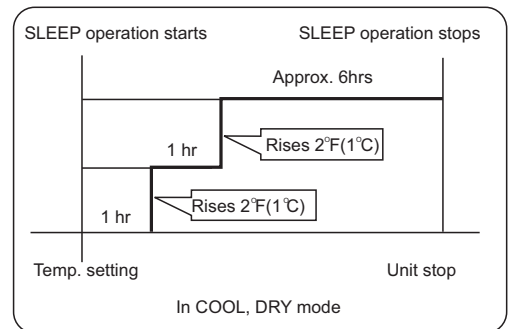

1. In HEAT mode

1 hours after SLEEP mode starts, temp will become 4°F(2°C) lower than temp. setting. After another 1 hours, temp decrease by 4°F(2°C) further. After more another for further 3 hours then stops. Temp. is lower than 3 hours, temp. rises by 2°F(1°C) further. The unit will run temp. setting so that room temperature won't be too high for your sleep.

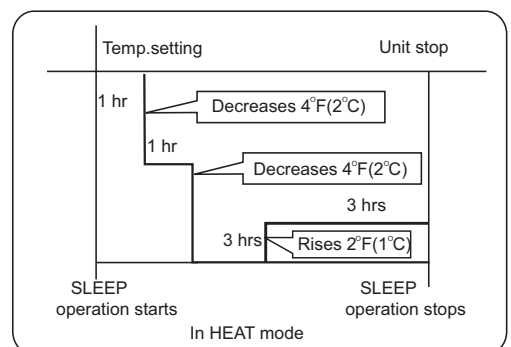

Parts and Functions

3. In AUTO mode

The unit operates in corresponding sleep mode corresponding sleep mode adapted to the automatically selected operation mode.

4. In FAN mode

It has no SLEEP function.

5. When quiet sleeping function is set to 8 hours the quiet sleeping time can not be adjusted. When TIMER function is set, the quiet sleeping function can't be set up. After the sleeping function is set up, if user resets TIMER function, the state of timing-on, if the two modes are set up at the same time, either of their operation time is ended first, the unit will stop automatically, and the other mode will be cancelled.

Note:

When TIMER function is set, the sleeping function can't be set up. After the sleeping function is set up, if user resets TIMER function, the sleeping function will be cancelled; the machine will be in the state of timing-on.

Note to the power failure resume:

Press the sleep button ten times in five seconds and enter function after hearing four sounds. And press the sleep button ten times within five seconds and leave this function after hearing two sounds.

Power Failure Resume Function



If the unit is started for the first time, the compressor will not start running unless 3 minutes have elapsed. When the power resumes after power failure, the unit will run automatically, and 3 minutes later the compressor starts running.

Healthy airflow Operation

1. Press  to starting.



Setting the comfortable work conditions.

2. The setting of healthy airflow function

Press  button to enter additional options, Press this button continuously, the louvers location will cycle between in the following three locations, to choose the swing location what you needed, and then press  button to confirm.



3. The cancel of the healthy airflow function

Press  button to enter additional options, Press this button continuously, the louvers location will cycle between in the following three locations again, and then press  button to cancel.

Notice: Do not direct the flap by hand. Otherwise, the grille will run incorrectly. If the grille is not run correctly, stop for a minute and then start, adjusting by remote controller.

Note:

1. After setting the healthy airflow function, the position grill is fixed.
2. In cooling, it is better to select the  mode.

3. In cooling and dry, using the air conditioner for a long time under the high air humidity, condensate water may occur at the grille.

Healthy airflow Operation

1. After unit starts, select your desired operation mode.

2. Press  /  button to change TIMER mode.

Press  button "ON 0.5" will appear, after 10 seconds the time display will be blank.

Press  button "OFF 0.5" will appear, after 10 seconds the time display will be blank.

Then select your desired TIMER mode (TIMER ON or TIMER OFF). "ON" or "OFF" will flash.

3. Press  /  button to set time.

Press the button for each time, setting time in the first 12 hours increased by 0.5 hour every time, after 12 hours, increased by 1 hour every time.

4. Confirm timer setting

After adjust the time, press  button and confirm the time ON or OFF button will not flash any more.

5. Cancel timer setting

Press the  button the time display eliminated.

Hints:

After replacing batteries or a power failure happens, time setting should be reset.

According to the Time setting sequence of TIMER ON or TIMER OFF, either Start-Stop or Stop-Start can be achieved.

HEALTH Operation (This function is unavailable on some models.)

Press HEALTH button, the remote controller will show  and then achieve to the health function.

Press again this HEALTH button, the health function will be cancelled.

The ion generator in the air conditioner can generate a lot of ion's effectively balance the quantity of positive and anion in the air and also to kill bacteria and speed up the dust sediment in the room and finally clean the air in the room.

TURBO Operation (This function is unavailable on some models.)

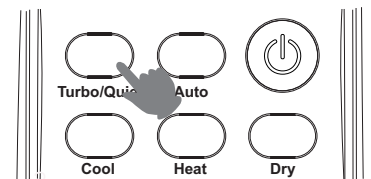

When you need fast cool or fast dehumidification, you can choose the Turbo function; when you sleep, read, you can choose Quiet function.

Press the  button, you can switch the "Turbo" and "Quiet" function easily. Every press, the remote controller will switch as below.

Parts and Functions

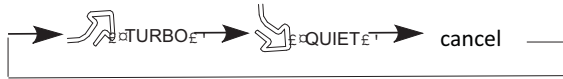

When running in Turbo, the fan speed is the highest, when running in Quiet, the fan speed is super slow

■ Loading of the battery

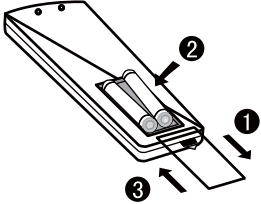



- 1.Remove the battery cover
- 2.Insert 2 AAA batteries as illustrated noting battery polarity
- 3.Reinstall the battery cover

Note:



The distance from the remote control to the receiver should be less than 7 meters with no obstructions.If the remote control display is weak or the operating distance has diminished,the batteries may need to be replaced.Remote control malfunctions can sometimes be corrected by removing the batteries from the remote for a few minutes and then reinstalling them.Remove the batteries from the remote control if the unit will not be in use for an extended period of time.if any segments of the display remain inactive after battery removal,press the reset button.

Troubleshooting

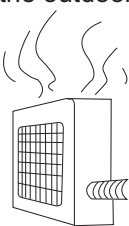
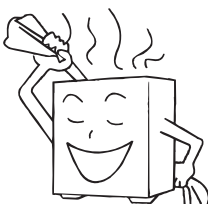
The followings are not malfunction





<p>Water flowing sound is heard</p> 	<p>When the air conditioner is started, when the compressor starts or stops during operation or when the air conditioner is stopped, it sometimes sounds "Bi- Bi-" or "Godo-Godo". It is the flowing sound of the refrigerant, not a malfunction.</p>
<p>Cracking sound is heard</p>	<p>This is caused by heat expansion or contraction of plastics</p>
<p>It smells.</p>	<p>Air blown out from the indoor unit sometimes smells. The smell results from smells of furniture, paint, tobacco absorbed by indoor unit.</p>
<p>During operation, white fog comes out of indoor unit.</p> 	<p>When in COOL or DRY mode, a thin water fog can be seen blown out of unit, this is the condensed fog because the suddenly cooled indoor air is blown out.</p>
<p>Automatically switch into FAN mode during cooling.</p>	<p>To prevent frost from being accumulated on the indoor unit heat exchanger, it sometimes automatically switched into the FAN mode, but it will soon back to the cooling mode.</p>
<p>The air conditioner cannot be restarted soon after it stops. Air conditioner does not start?</p> 	<p>This is because of the self-protection function of the system, therefore, it cannot be restarted for about three minutes after it stops. Please wait for three minutes</p>
<p>Air does not blow or the fan speed cannot be changed during drying.</p>	<p>In DRY mode, when room temperature becomes 2°C higher than temperature setting, unit will run intermittently at LO speed regardless of FAN setting</p>
<p>Water or vapor generated from the outdoor unit during heating.</p> 	<p>This happens when the frost accumulated on the outdoor unit is removed (during defrosting operation).</p> <p style="text-align: right;">Defrosting operation</p> 
<p>During heating, indoor fan is still running even unit is stopped.</p>	<p>To get rid of the excess heat, indoor fan will continue running for a while after unit automatically stops.</p>

Please check the following things about your air conditioner before making a service call.

Unit fails to start.		
<p>Is the power supply switch on ?</p>  <p>Power supply switch is not in ON position.</p>	<p>Is city supply power normal ?</p> 	<p>Is the earth leakage breaker in action ?</p> <p>Be sure to turn off the power supply switch immediately and contact the sales dealer.</p>

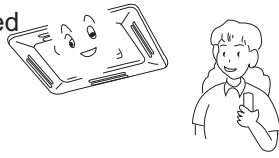
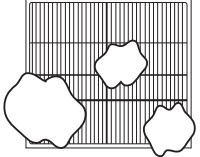
Troubleshooting

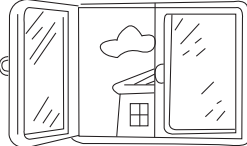
Insufficient cooling or heating

<p>The operation controller adjusted as required</p> 	<p>Air filter too dirty ?</p> 	<p>Horizontal swing louver upward ? (in HEAT mode)</p> 
<p>Any obstacle exists at the air inlet or outlet?</p> 	<p>Door or window left opened ?</p> 	

Insufficient cooling

<p>Any other heat sources in the room?</p> 	<p>Sunlight direct into the room ?</p> 	<p>Too crowded in the room ?</p> 
--	--	--

Cooled air blown out (when heating)

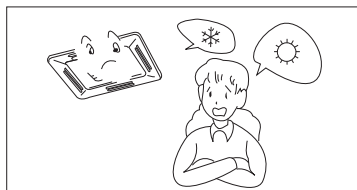

When the air conditioner does not operate properly after you have checked the above-mentioned items or when following phenomenon is observed, stop the operation of the air conditioner and contact your sales dealer.

- 1)The fuse or breaker often shuts down.
- 2)Water drops off during cooling or drying operation.
- 3)There is an irregularity in operation or abnormal sound that is audible.

When failure happens, the fan of indoor unit stop running.

For indoor failure, only running LED of remote receiver will indicate,

For outdoor failure, timer LED and running LED will indicate .timer LED of remote receiver stands for ten's place, and running LED stands for one's place. Timer LED will flash firstly, 2 seconds later, running LED will flash too.After that finishes, 4 seconds later, they will flash in turns again. Flash times is the failure of outdoor + 20.

For example,failure code that outdoor is 2, so indoor unit should display 22. As a result, timer LED flashes twice firstly, then running LED flashes twice.

Ta: ambient temperature sensor
Tm: coil temperature sensor

Trouble shooting	FAILURE CODE(running led of indoor receive board flashes times)	POSSIBLE REASONS
Faulty temperature Ta	1	Sensor disconnected, or broken, or at wrong position, or short circuit
Faulty temperature Tm	2	Sensor disconnected, or broken, or at wrong position, or short circuit
Faulty EEPROM on indoor unit PCB	4	Faulty indoor unit PCB
Abnormal communication between indoor and outdoor units	7	Wrong connection, or the wires be disconnected, or wrong address setting of indoor unit, or faulty power supply or faulty PCB
Abnormal communication between indoor wired controller and indoor unit PCB	8	Wrong connection, or the wired controller be disconnected, faulty PCB
Drainage system abnormal	12	Pump motor disconnected, or at wrong position, or the float switch broken down, or the float switch disconnected,or at wrong position
Zero cross sigal wrong	13	Zero cross sigal detected wrong
Indoor abnormal mode operation	16	Different from outdoor unit mode

For the outdoor failure indicated by the indoor unit, please refer to the outdoor failure code list

Customer Need-to-know

Customer Need-to-know

- Please install the air conditioner according to the requirements specified in this manual to ensure the air conditioner work well.
- Be careful not to scratch the surface of the case during moving the air conditioner.
- Please keep the installation manual for future reference when maintenance and changing installation place.
- After installation ,please use the air conditioner according to the specification in the operation manual.

Using Directions

Adjust suitable airflow direction

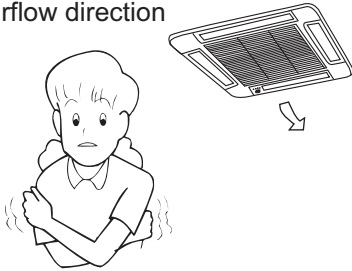

Avoid direct sunlight and airflow



Keep the proper indoor temperature.
Too cool or hot is not good for your health.
Furthermore, it will result in excessive consumption of electric power.

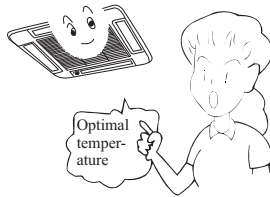

Effectively use timer.

Using TIMER mode, you can make the room temperature reach a suitable temperature when you wake up or back home.

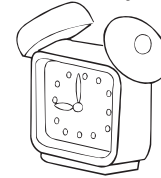

Maintenance

Seasonal Reserve

Post-season Care

Operate the unit with FAN mode on a fair day for about half a day to dry the inside of the unit well.

Stop operation and turn off the power supply switch .Electric power is consumed even the air conditioner is in stop.



Clean the air filter, indoor unit and outdoor unit, and cover the unit with dustcoat.

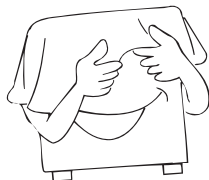

Pre-season Care

See that there is no obstacles blocking the air inlet and air outlet of both indoor and outdoor unit to avoid reduce the working efficiency.

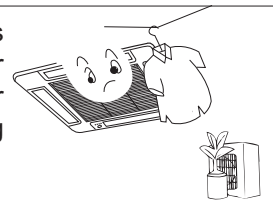

Be sure to install the air filter, ensure that the air filter is not dirty. Otherwise may result in machine damage or cause malfunction to the dust inside the unit

To prevent compressor failure during Heat mode, please turn on the power supply switch 12 hours before operating the unit. Furthermore always keep the power supply switch on during winter season





NOTE:

The inner part of indoor unit must be cleaned. Consult dealer, because clean must be done by technician. In cooling operation, discharging system discharge water in room.

Maintenance

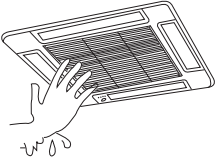
Clean the unit

Turn off the power supply switch	Do not touch with wet hand.	Do not use hot water or volatile liquid
		

NOTE: For detailed information consult dealer.

Air filter washing

- Please don't tear down the air filter, or it may lead to
- trouble.

If the environment where the aircon works is full of dust, the air filter should be wash more times than ever (it is usually twice a week).

1. Get the air inlet grille

Look at picture 1, press the two embedding switch vertically to make it close to the side grille, then raise it for about 45° to take the air inlet grille down.

Press the embedding switch according to the direction of the arrowhead.

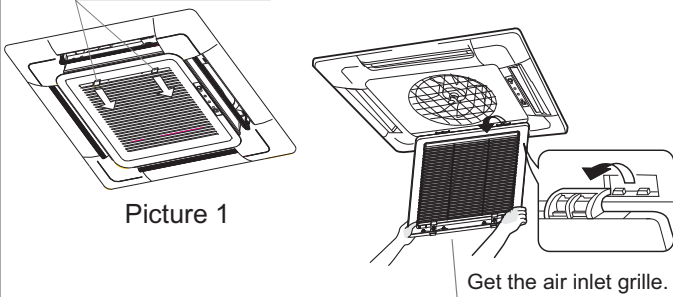

2. Tear down the air filter (Picture 2)

Press the outer brim of the air inlet grille with your thumb, at the same time, pull out the bottom rim of the filter net slightly with your forefinger, so the filter net can part from the embedding switch for us to get it easily.

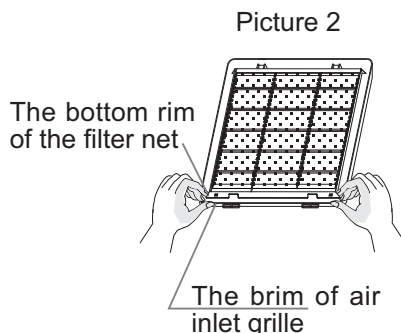

PS: the pictures above are only models, pls obey the real machinery.

Clean the air inlet grille

(1). Open air inlet grille

Pull the two handles at the same time, slowly draw them out. (when closing it, the procedure is reversed.)

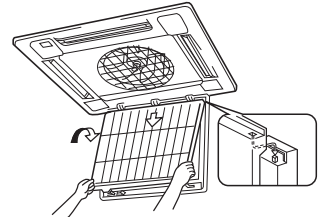

(2). Remove air filter

Referring to "Clean the air filter".

(3). Remove the air inlet grille

Open the air inlet grille for 45°, the lift it up.

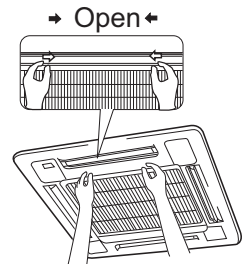

(4). Clean

⚠ Notice

Do not use the hot water over 50° C to clean to avoid discoloration or deformation.

Use soft brush, water and neutral detergent to clean, then throw the water off.

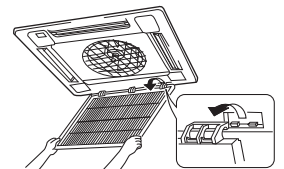

When there is too much dust

Use ventilation fan or directly spray the detergent special for kitchen ware on the air inlet grille, 10 minutes later use water to clean.

(5). Install air inlet grille

Referring to procedure 3.

(6). Install the air filter

Referring to "Clean the air filter"

(7). Close air inlet grille

Referring to procedure 1.

Installation Procedure

CAUTIONS:

To ensure proper installation, read "Cautions" carefully before working. After installation, start the unit correctly and show customers how to operate and maintain the unit.

Meanings of Warning and Cautions:

⚠ **WARNING:** Serious injury or even death might happen, if it is not observed.

⚠ **CAUTION:** Injury to people or damages to machine might happen, if it is not observed.

⚠ **WARNING:**

- Installation shall be done by professional people, don't install unit by yourself. Incorrect installation will cause water leakage, electric shock or fire.
- Install unit as per the Manual. Incorrect installation will cause water leakage, electric shock or fire accident.
- Be sure to use specified accessories and parts. Otherwise, water leakage, electric shock, fire accident or unit falling down may happen.
- Unit should be placed on a place strong enough to hold the unit. Or, unit will fall down causing injuries.
- When install the unit, take in consideration of storms, typhoon, earthquake. Incorrect installation may cause unit to fall down.
- All electric work shall be done by experienced people as per local code, regulations and this Manual.
- Use exclusive wire for the unit. Incorrect installation or undersized electric wire may cause electric shock or fire accident.
- All the wires and circuit shall be safe. Use exclusive wire firmly fixed. Be sure that external force will not affect terminal block and electric wire. Poor contact and installation may cause fire accident.
- Arrange wire correctly when connecting indoor and outdoor power supply. Fix terminal cover firmly to avoid overheat, electric shock or even fire accident.
- In case refrigerant leakage occurred during unit installation, keep a good ventilation in the room.
- Poisonous gas will occur when meet with fire.
- Check the unit upon installation. Be sure there is no leakage. Refrigerant will induce poisonous gas when meet heat source as heater, oven, etc.
- Cut power supply before touching terminal block.

⚠ **CAUTION:**

- Unit shall be grounded. But grounding shall not be connected to gas pipe water pipe, telephone line. Poor grounding will cause electric shock.
- Be sure to install a leakage breaker to avoid electric shock.
- Arrange water drainage according to this Manual. Cover pipe with insulation materials in case dew may occur. Improper installation of water drainage will cause water leakage and wet your furniture.
- To maintain good picture or reduce noise, keep at least 1 m from T.V. radio, when install indoor and outdoor unit, connecting wire and power line. (If the radio wave is relatively strong, 1 m is not enough to reduce noise).
- Don't install unit in following places:
 - (a) Oil mist or oil gas exists, such as kitchen, or, plastic parts may get aged, or water leakage.
 - (b) Where there is corrosive gas. Copper tube and welded part may be damaged due to corrosion, causing leakage.
 - (c) Where there is strong radiation. This will affect unit's control system, causing malfunction of the unit
 - (d) Where flammable gas, dirt, and volatile matter (thinner, gasoline) exist, These matter might cause fire accident.
- Refer to paper pattern when installing unit.



Cautions for the installation personnel

Don't fail to show customers how to operate unit.

Installation Procedure

1 BEFORE INSTALLATION <Don't discard any accessories until comp>

- Determine the way to carry unit to installation place.
- Don't remove packing until unit reaches installation place.
- If unpacking is unavoidable, protect unit properly.

2 SELECTION OF INSTALLATION PLACE

(1) Installation place shall meet the following and agreed by customers:

- Place where proper air flow can be ensured.
- No block to air flow.
- Water drainage is smooth.
- Place strong enough to support unit weight.
- Place where inclination is not evident on ceiling.
- Enough space for maintenance.
- Indoor and outdoor unit piping length is within limit. (Refer to Installation Manual for outdoor unit.)
- Indoor and outdoor unit, power cable, inter unit cable are at least 1 m away from T.V & radio. This is helpful to avoid picture disturbance and noise. (Even if 1 m is kept, noise can still appear if radio wave is strong)

(2) Ceiling height

Indoor unit can be installed on ceiling of 2.5-3m in height. (Refer to Field setting and Installation Manual of ornament panel.)

(3) Install suspending bolt.

Check if the installation place is strong enough to hold weight. Take necessary measures in case it is not safe. (Distance between holes are marked on paper pattern. Refer to paper pattern for place need be reinforced)

Model	H
AB09CS2ERA AB12CS2ERA(S) AB18CS2ERA(S)	320
AB24ES1ERA(S)	300

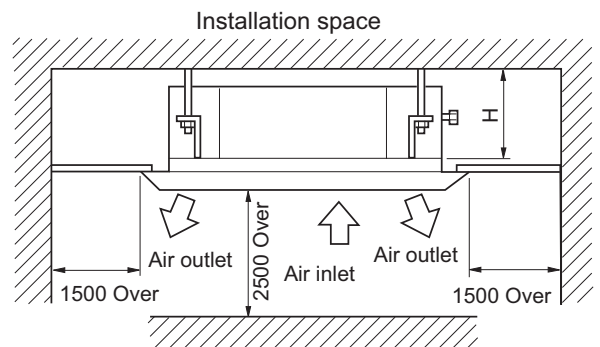

3 PREPARATION FOR THE INSTALLATION

(1) Position of ceiling opening between unit and suspending bolt.

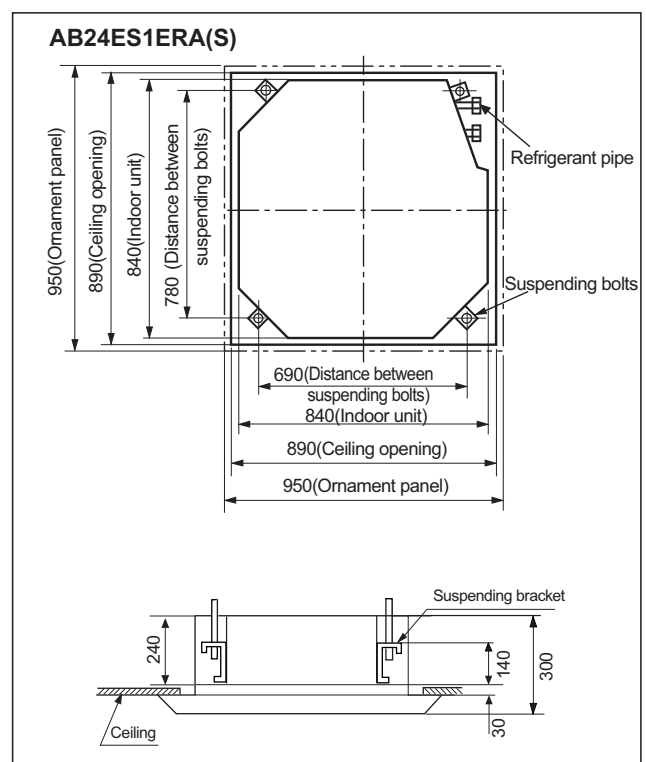
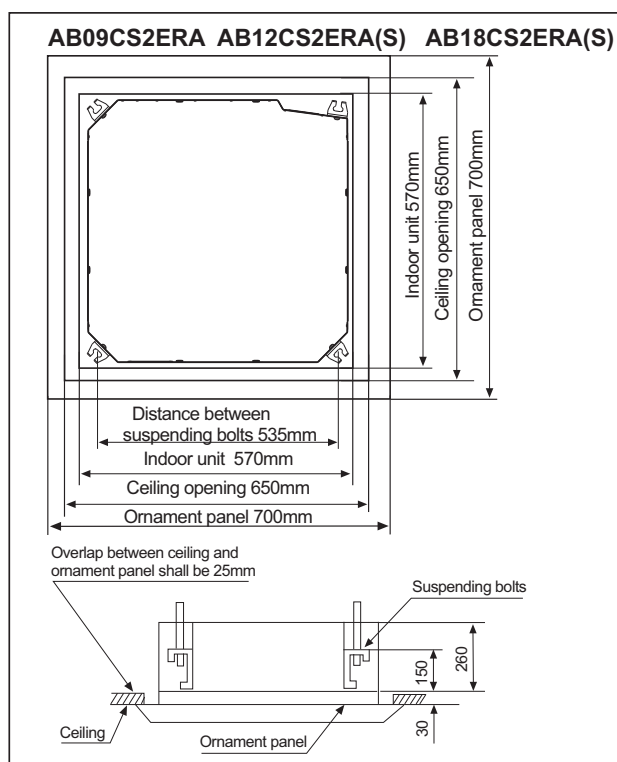

Installation Procedure

(2) Cut an opening in ceiling for installation if necessary. (when ceiling already exists.)

- Refer to paper pattern for dimension of ceiling hole.
- Connect all piping (refrigerant, water drainage), wiring (inter unit cable) to indoor unit, before installation.
- Cut a hole in ceiling, may be a frame should be used to ensure a smooth surface and to prevent vibration.
- Contact your real estate dealer

(3) Install a suspending bolt. (Use a M10 bolt)

- To support the unit weight, anchor bolt shall be used in the case of already exists ceiling. For new ceiling, use built in type bolt or parts prepared in the field.
- Before going on installing adjust space between ceiling.

Note: All the above mentioned parts shall be prepared in field.

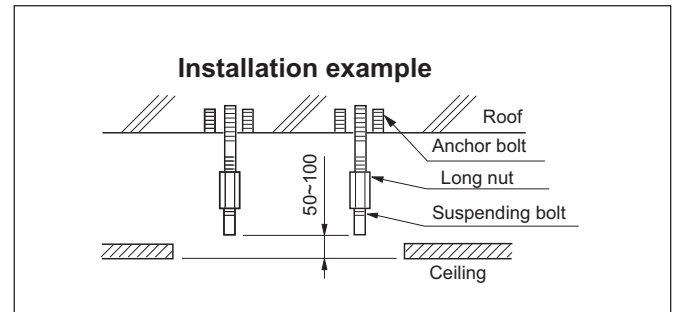

4 INSTALLATION OF INDOOR UNIT

In the case of new ceiling

(1) Install unit temporarily

Put suspending bracket on the suspending bolt. Be sure to use nut and washer at both ends of the bracket.

(2) As for the dimensions of ceiling hole, see paper pattern. Ask your real estate dealer for details.

Center of the hole is marked on the paper pattern.

Center of the unit is marked on the card in the unit and on the paper pattern.

Mount paper pattern ⑤ onto unit using 3 screws ⑥. Fix the corner of the drain pan at piping outlet.

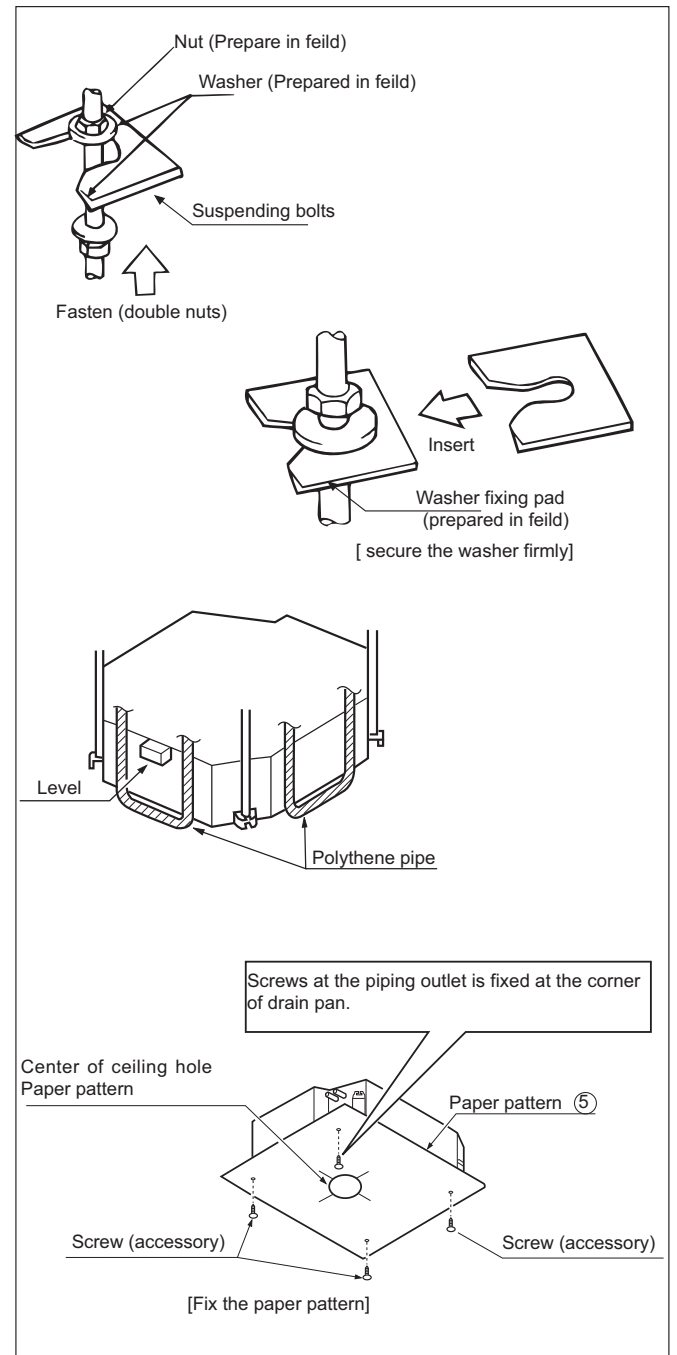

<After installation on the ceiling>

(3) Adjust unit to its right position. (Refer to preparation for the installation-(1))

(4) Check unit's horizontal level.

Water pump and float switch is installed inside indoor unit, check four corners of the unit for its level using horizontal compartor or PVC tube with water. (If unit is tilting against the direction of water drainage, problem may occur on floating switch, causing water leakage.)

(5) Remove the washer mounting ② and tighten the nut above.

(6) Remove the paper pattern.

In the case of ceiling already exists

(1) Install unit temporarily

Put suspending bracket on the suspending bolt. Be sure to use nut and washer at both ends of the bracket. Fix the bracket firmly.

(2) Adjust the height and position of the unit. (Refer to preparation for the installation (1)).

(3) Proceed with ③ and ④ of "In the case of new ceiling".

Installation Procedure

⑤ REFRIGERANT PIPING (As for outdoor piping, please refer to installation Manual of outdoor unit.)

- Outdoor is precharged with refrigerant.
- Be sure to see the Fig.1, when connecting and removing piping from unit.
- For the size of the flare nut, please refer to Table 1.
- Apply refrigerant oil at both inside and outside of the flare nut. Tighten it band tight 3-4 turns then tighten it.
- Use torque specified in Table 1. (Too much force may damage flare nut, causing gas leakage).
- Check piping joints for gas leakage. Insulate piping as shown in Fig. below.
- Cover joint of gas piping and insulator ⑦ with seal.

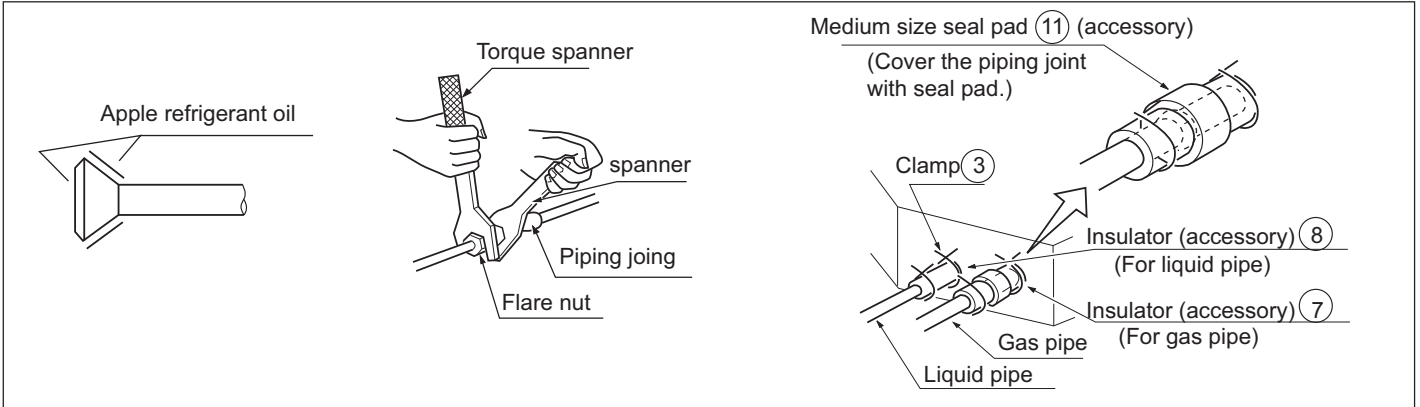

Table 1

Pipe size	Tighten torque	A(mm)	Flare shape
φ6.35	1420~1720N.cm (144~176kgf.cm)	8.3~8.7	
φ9.52	3270~3990N.cm (333~407kgf.cm)	12.0~12.4	
φ12.7	4950~6030N.cm (490~500kgf.cm)	12.4~16.6	
φ15.88	6180~7540N.cm (630~770kgf.cm)	18.6~19.0	
φ19.05	9720~11860 N.cm (990~1210 kgf.cm)	22.9~23.3	

⑥ INSTALLATION OF WATER DRAINAGE PIPE

(1) Install water drainage pipe

- Pipe dia, shall be equal or larger than that of unit piping.(pipe of polyethylene; size: 25mm; O.D:32mm)
- Drain pipe should be short, with a downward slope at least 1/100 to prevent air bag from happening.
- If downward slope can't be made, take other measures to lift it up.
- Keep a distance of 1-1.5m between suspending brackets, to make water hose straight.

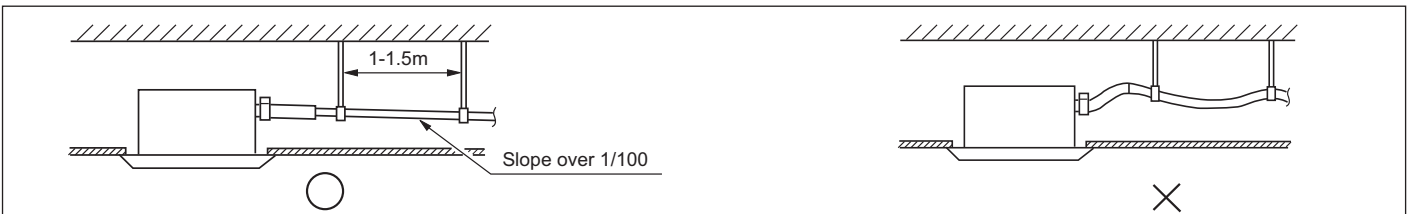

- Use the self-provided stiff pipe and clamp ① with unit. Insert water pipe into water plug until it reaches the white tape. Tighten the clip until head of the screw is less than 4mm from hose.
- Wind the drain hose to the clip using seal pad ⑨.
- Insulate drain hose in the room.

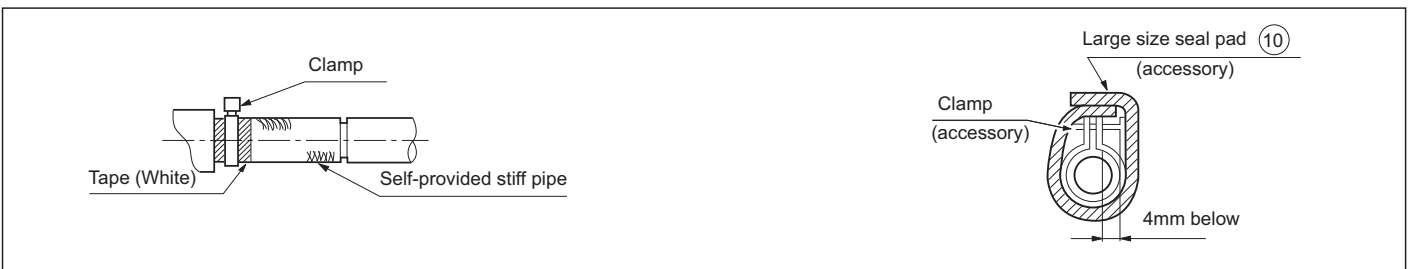

Installation Procedure

<Cautions for the drain water lifting pipe >

Installation height shall be less than 280mm.
There should be a right angle with unit, 300mm from unit.

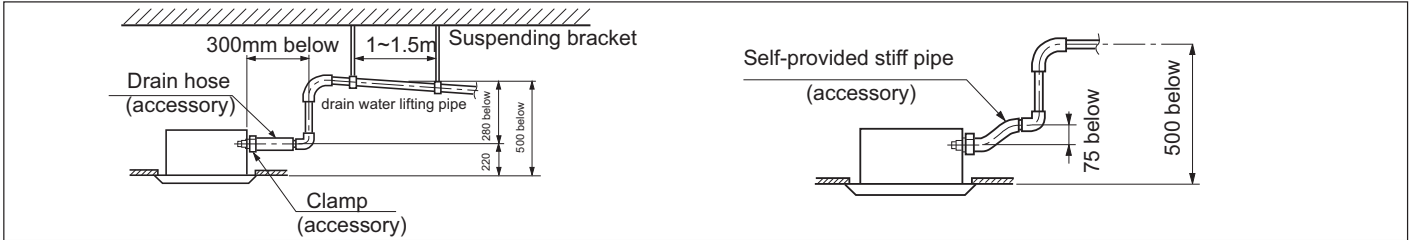

Note:

The slope of water drain hose (1) shall be within 75mm, don't apply too much force on it.
If several water hoses join together, do as per following procedure.

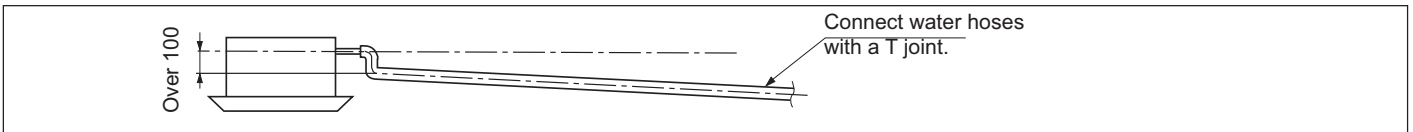

Specification of the water hoses shall meet the requirements for the unit running.

(2) Check if water drainage is smooth after installation.

- Check whether indoor unit is horizontal with leveler or polythene pipe filled with water, and check that the dimension of the ceiling opening is correct. Take off the lever gauge before install the ornament panel.
- Fasten the screws to make the height difference between the two sides of indoor unit less than 5mm.
- First fix it with screws temporarily.
- Fasten the two temporarily fixing screws and other two, and tighten the four screws.
- Connect the wires of synchro-motor.
- Connect the wire of signal.
- If no response of remote controller, check whether the wiring is correct, restart remote controller 10 seconds after shut off power supply.

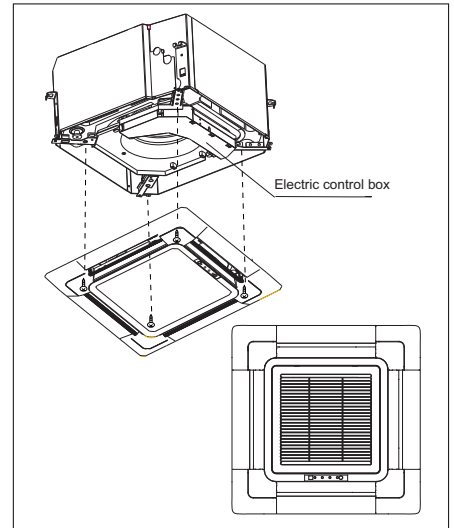

<Limits of panel board installation>

- Install the panel board in the direction shown in the figure. The incorrect direction will result in water leakage, meanwhile swing and signal receiving are displayed that cannot be connected.
- Charge, through air outlet or inspecting hole, 1200ccd water to see water drainage.

After wiring

- Check water drainage in cooling operation.

When wiring is not complete

- Remove cover of control box, connect 1PH power to terminal 1 and 2 on terminal block.,use remote controller to operate the unit.
- Note, in this operation, fan will be running.
- Upon confirmation of a smooth water drainage, be sure to cut off power supply.

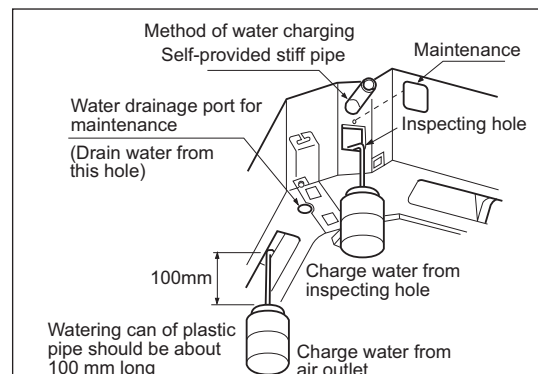
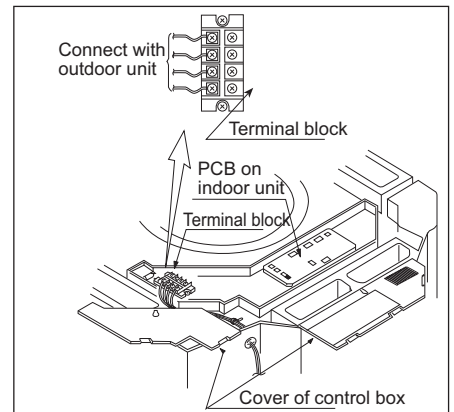

AB09CS2ERA
AB12CS2ERA(S)
AB18CS2ERA(S)
AB24ES1ERA(S)

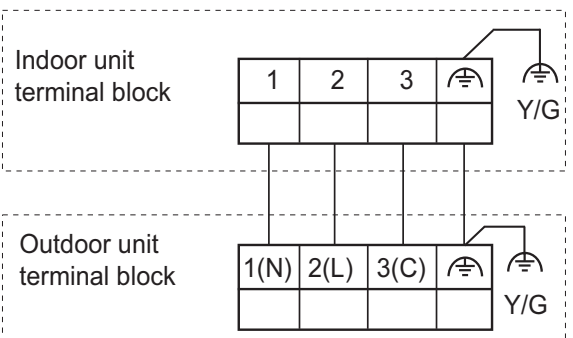

Installation Procedure

7 WIRING

- All supplied parts, materials and wiring operation must in appliance with local code and regulations.
- Use copper wire only.
- When make wiring, please refer to wiring diagram also.
- All wiring work must be done by qualified electricians.
- A circuit breaker must be installed, which can cut power supply to all system.
- See Installation Manual of outdoor unit for specifications of wires, circuit breaker, switches and wiring etc.
- Connecting of unit
Remove cover of switch box (1), drag wires into rubber tube A, then, after proper wiring with other wires, tighten clamp A. Connect wires of correct pole to the terminal block inside.
Wind seal ⑫ around wires. (Be sure to do that, or dew may occur).
- Upon condensation, replace control box cover (1) and (2).

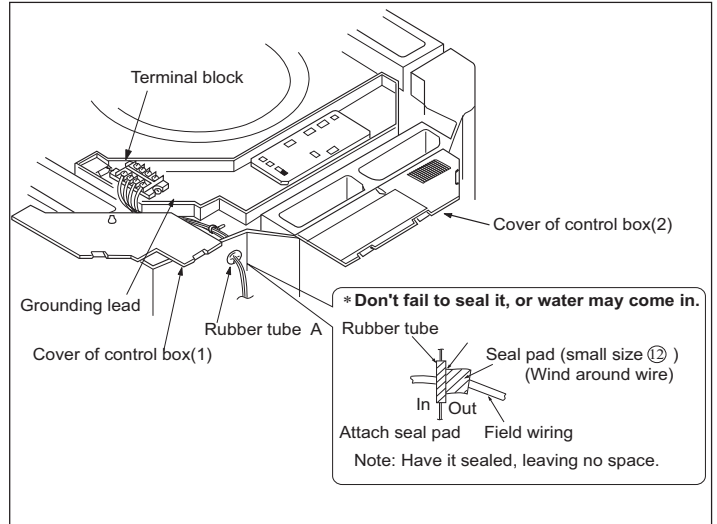

⚠ WARNING:

Observe the following when connecting power supply terminal block:
Don't connect wires of different specifications to the same terminal block.
(Loose wire may cause overheating of circuit)
Connect wires of same specifications as shown in right Fig.

Connect wires of the same specifications at two sides.

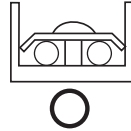

Don't connect wires of the same specifications at one side.

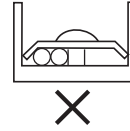

Don't connect wires of the different specifications.

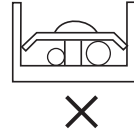

8 WIRING EXAMPLE

As for outdoor unit circuit, please see Installation Manual of outdoor unit.
Note: All electric wires have their own poles, poles must match that on terminal block.

Pay special care to the following and check after installation

Item to the checked	Improper installation may cause	Check
Is indoor unit firmly installed?	Unit might fall down, make vibration or noise.	
Is gas leakage check performed?	This may lead to gas shortage.	
Is unit properly insulated?	Dew or water drop may occur.	
Is water drainage smooth?	Dew or water drop may occur.	
Is power voltage meet that stipulated on the nameplate?	Problem may occur or parts got burned.	
Is wiring and piping correctly arranged?	Problem may occur or parts got burned.	
Is unit safely grounded?	There might be a danger of electric shock.	
Is wire size correct?	Problem may occur or parts got burned.	
Are there any obstacles on air inlet and outlet grill of indoor and outdoor unit?	This may cause poor cooling.	
Is record made for piping length and refrigerant charging amount?	It is hard to control refrigerant charging amount.	

Attention: after finishing installation, confirm no refrigerant leakage.



Haier

Address: Haier Industrial Park, Qianwangang Road, Eco-Tech Development Zone, Qingdao 266555, Shandong, P.R.C.

Contacts: TEL +86-532-88936943; FAX +86-532-8893-6999

Website: www.haier.com