

# Haier

## User Manual Dishwasher

HDWI5F3SI / HDWI5F3BI

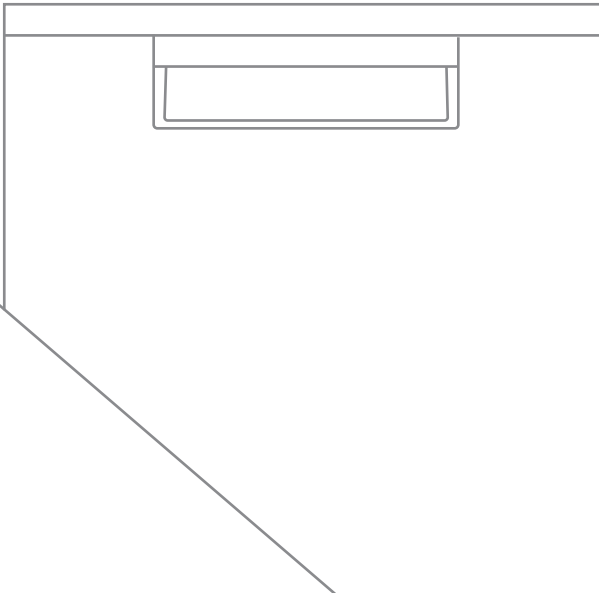

NZ AU

Please read these instructions carefully before using this appliance. The instructions contain important information which will help you get the best out of the appliance and ensure safe and proper installation, use and maintenance.

Keep this manual in a convenient place so you can always refer to it for the safe and proper use of the appliance.

If you sell the appliance, give it away, or leave it behind when you move house, make sure you also pass on this manual so that the new owner can become familiar with the appliance and safety warnings.

## Legend



General information and tips



Warning—Important Safety information



Environmental information

## Disposal



Help protect the environment and human health. Put the packaging in applicable containers to recycle it. Help to recycle waste of electrical and electronic appliances. Do not dispose appliances marked with this symbol with the household waste. Return the product to your local recycling facility or contact your municipal office.



### **WARNING!**

Risk of injury or suffocation!

Disconnect the appliance from the mains supply. Cut off the mains cable and dispose of it. Remove the door catch to prevent children and pets to get closed in the appliance.

Safety .....	3
Installation .....	5
Technical Data .....	10
Product Description .....	11
Control Panel .....	12
Programme .....	15
Before first use .....	16
Daily Use .....	21
Wi-Fi Connection .....	28
Care and Cleaning .....	29
Troubleshooting .....	31
Customer service .....	34
Standards Test .....	35

## Intended Use

The appliance is designed for domestic use inside the house, or in similar applications such as staff kitchen areas in working environments, farm houses, by clients in hotels, motels or other residential environments, and bed and breakfast environments. It is not intended for commercial or industrial use. Do not use it for purposes other than that for which it was designed.

Changes or modifications to the device are not allowed. Unintended use may cause hazards and loss of warranty claims.

## Standards and Directives

This product meets the requirements of all applicable EC directives with the corresponding harmonised standards, which provide for CE marking.

## Before Switching on the Appliance for the First Time Do...

- ▶ make sure all packaging is removed and is kept out of children's reach.
- ▶ make sure that the electrical information on the rating plate agrees with the power supply. If it does not, contact an electrician.
- ▶ use a separate earthed socket for the power supply. The appliance must be earthed.
- ▶ make sure the plug is easy accessible.
- ▶ make sure only the delivered electric cable and hose set are used.
- ▶ hold the plug and not the electric cable when unplugging the power supply.
- ▶ make sure not to damage the electric cable and the plug. If damaged, have it replaced by an electrician.
- ▶ make sure the hose joints and connections are firm and there is no leakage.

## Do not...

- ✗ install or use the appliance where the temperature is below 5 °C. use multi-plug adapters and extension cables.
- ✗ let persons, children included, with reduced physical sensory, reduced mental functions or lack of experience and knowledge use the appliance if not supervised by a person responsible for their safety.
- ✗ put flammable products or items that are wet with flammable products in, near, or on the appliance.

## During Daily Use

### Do...

- ▶ supervise children to prevent them playing with the appliance.
- ▶ put sharp pointed objects (e.g. knives) in a way that there is no danger of injury.

### Do not...

- × open the door while a programme operates. The appliance can release hot steam.
- × keep the appliance door open without supervision to prevent tripping and falling.
- × let children or pets come close to the appliance when the door is open.
- × sit or place heavy items on the open door.
- × remove the dishes from the appliance until the programme is completed. There can still be detergent on the dishes.
- × drink the water in the appliance. The water may be contaminated with detergent residues.
- × cover any ventilation openings in the base by a carpet or similar object.
- × use water spray or steam to clean the appliance.
- × let the children make the cleaning and user maintenance without supervision.

## WARNING:

Some dishwasher detergents are strongly alkaline. They can be extremely dangerous if swallowed. Avoid contact with the skin and eyes and keep children away from the dishwasher when the door is open. Check that the detergent receptacle is empty after completion of the wash cycle.

- The door is not left in the open position since this could present a tripping hazard.
- Warning: Knives and other utensils with sharp points must be loaded in the basket with their points down or placed in a horizontal position.
- Only use hose-set provided by manufacture, old hose-set cannot be reused.



## WARNING!

Any installation may be carried out only by a qualified technician refer to section SAFETY.

## Free Standing Installation

Install the appliance on solid ground. Adjust accurately all feet to get a firm, horizontal position.



Only with a correct level the appliance door closes and seals correctly.

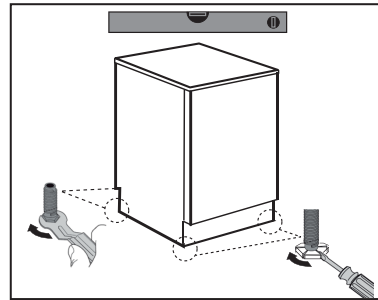

## Installation under Worktop

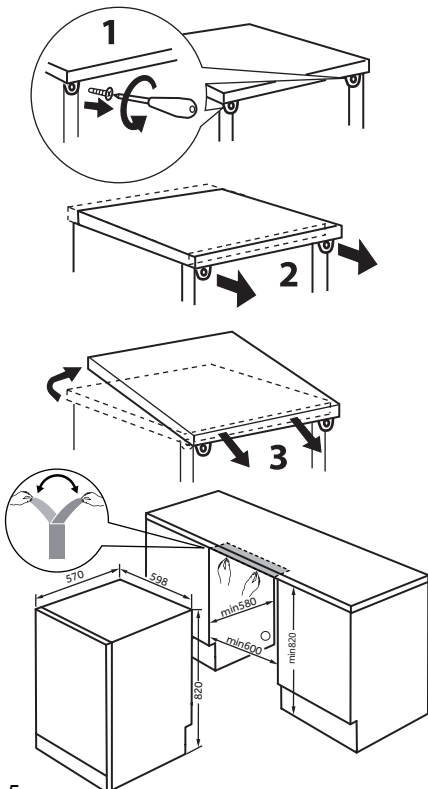

1. Optional: Remove the work top of the appliance.
2. Adjust accurately all feet to get a firm level position.
3. Stick the water-proof sticker on the bottom of the kitchen board
4. Install the appliance carefully into the recess.



## WARNING!

- ▶ If used as free standing appliance again, the worktop must be remounted.
5. The dimensions of the recess should at least agree with the dimensions in the figure.
  6. After installation, the minimum gap between the side panel and the cupboard is 1mm, and the minimum gap between the rear and the cupboard is 10mm. The top gap is controlled by adjusting the feet.
  7. Put the appliance adjacent to the slot. Make sure that all connections (water, drain water, power) are neatly positioned and connected.

## Fresh Water Connection

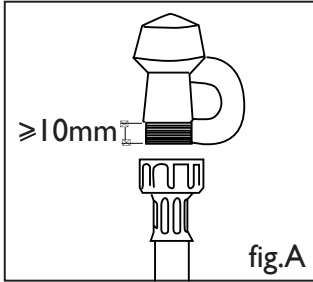

### IMPORTANT!

- ▶ The appliance should be connected to the water main using the new water inlet hose supplied. Old hoses should not be used.
- ▶ Do not shorten the inlet hose.

1. Take note of water connection requirements.
  - ▶ The dishwasher has a single valve water connection.
  - ▶ We recommend a cold water connection for best performance and energy efficiency.
  - ▶ The incoming water temperature should not exceed  $25^{\circ}\text{C}$ .
2. Take note of the permitted water pressure extremes.
  - ▶ Lowest:  $0.3\text{ bar} = 3\text{ N/cm}^2 = 30\text{kPa}$
  - ▶ Where pressure is below 1 bar, contact a qualified plumber.
  - ▶ Highest:  $10\text{ bar} = 100\text{ N/cm}^2 = 1\text{MPa}$
  - ▶ Where pressure is above 10 bar, a pressure reduction valve must be installed. Contact a qualified plumber.
3. Connect the water inlet hose to an accessible water tap with a  $3/4''$  BSP connector (see fig.A). Ensure that there is no kink in the inlet hose that could restrict the flow of water. A  $90^{\circ}$  bend requires a minimum height of 200 mm for a kink-free curve.
  - ▶ Ensure incoming water is clear. If the water pipes have not been used for a long period of time, let the water run to make sure it is clear with no impurities. Not doing so may result in the water inlet hose getting blocked and damaging the appliance.
  - ▶ If required, use a filter insert to filter out deposits from the piping. The filter insert is available from your Authorised Service Centre or Customer Care.
4. Tighten the hose coupling a further half turn after seal contact.
5. Check that the connection does not leak.

## Anti-Flooding protection

The dishwasher is equipped with a system that stops the supply of water in the event of a problem with the water supply hose, or leaks within the unit, in order to prevent damage to your home. If for any reason the box containing the electrical components happens to get damaged, turn off the power supply and remove the plug for the appliance from the socket immediately. In order to guarantee that the anti-flooding feature operates properly, the “A” box with water supply hose must be attached to the water supply tap as shown in fig.B. No other type of connection is acceptable. The water supply hose must not, under any circumstances, be cut, as it contains electrical parts which are live. If the length of the hose is not adequate to make a proper connection, the hose must be replaced with one which is long enough. This hose is available upon request from specialised retailers and Authorised Service Center.

## Drain Water Connection

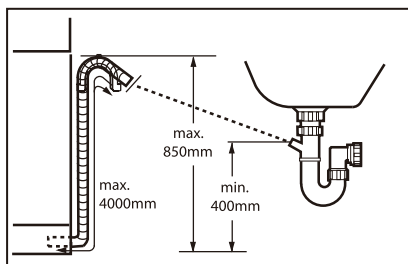

Fix the water drain hose properly to the piping. The hose has to reach at one point a height between 400 and 850 mm above the appliance bottom line!

An extension hose for the water drain hose must not exceed a total length of 4 m and must have the same diameter as the water drain hose.

Following connections are possible:

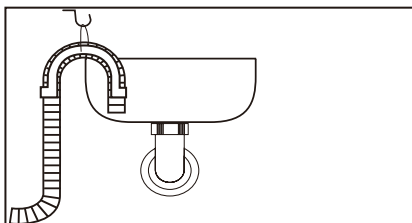

### Drain hose to sink

- ▶ Hang the drain hose with the U-support over the edge of a sink with adequate size.
- ▶ Protect the U-support sufficiently against slipping.



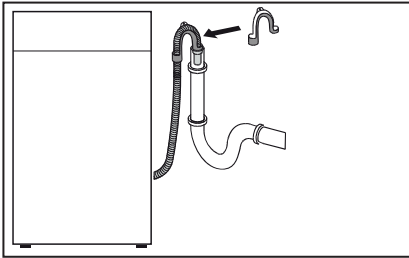

### Drain hose to waste water connection

- ▶ The internal diameter of the stand pipe with vent-hole must be minimum 40 mm.
- ▶ Put the drain hose for approx. 80 mm in the wastewater pipe.
- ▶ Attach the U-support and secure it sufficiently

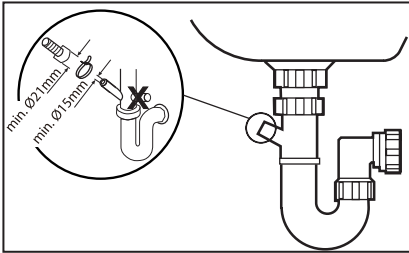

### Drain hose to sink connection

- ▶ When connecting the drain hose to a sink trap with a drain hose spigot, make sure that the drain hose is supported to the height of the bench.
- ▶ Ensure the drain spigot has a minimum hole diameter of 15 mm and it has been drilled out.

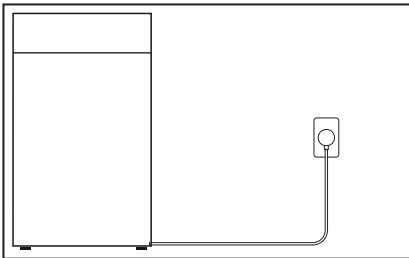

### Power connection

As shown in the figure, the power supply is plugged into an externally accessible place through the service hole for easy plugging.



### CAUTION!

Ensure always that all connections (power supply, drain and fresh water hose) are firm, dry and leak free!

Take care these parts are never to be crushed, kinked, or twisted. If the supply cord is damaged, it must be replaced by the service agent (see warranty card) in order to avoid a hazard.

## Service hole

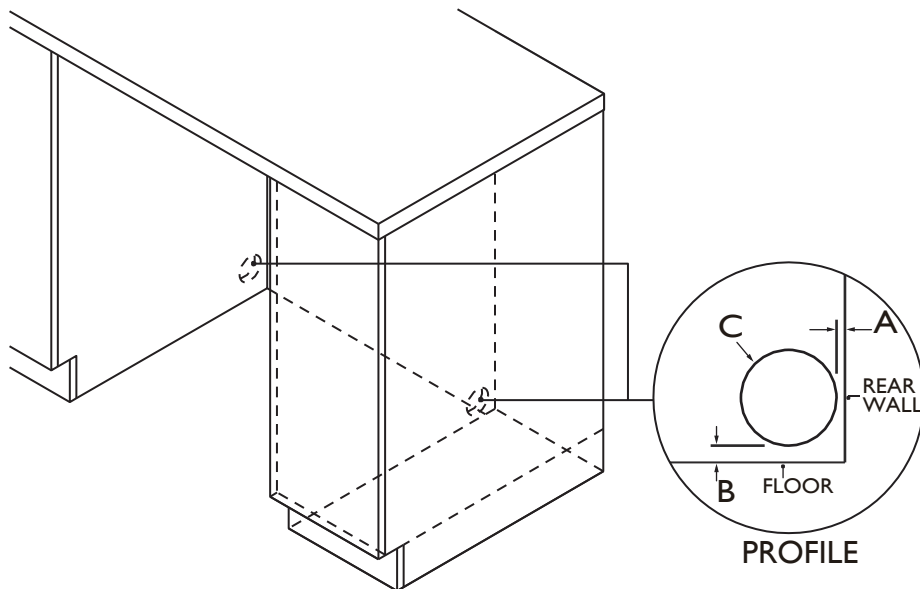

### SERVICE HOLEDIMENSIONS

MM

A	Maximum distance between rear of cavity and service hole*	15
B	Maximum distance between floor and service hole**	0-50
C	Minimum diameter of service hole	70

\* based on a cabinetry depth of 580mm

\*\* depending on adjustment of levelling feet

Check the electrical data on the rating label (located on the left-hand side of the dishwasher's stainless steel inner door). Should the data on the rating label be different to those specified below, consider those on the rating label as correct.

Suppliers name or trade mark	Haier
Supplier's model identifier	HDWI5F3SI / HDWI5F3BI
Rated capacity in standard place settings	15
Mainswater pressure	0.03 - 1Mpa (=0.3 - 10bar)
Power voltage	220-240 V (50Hz)
Maximum current intensity	10 A
Total absorbed power	1720-2050 W

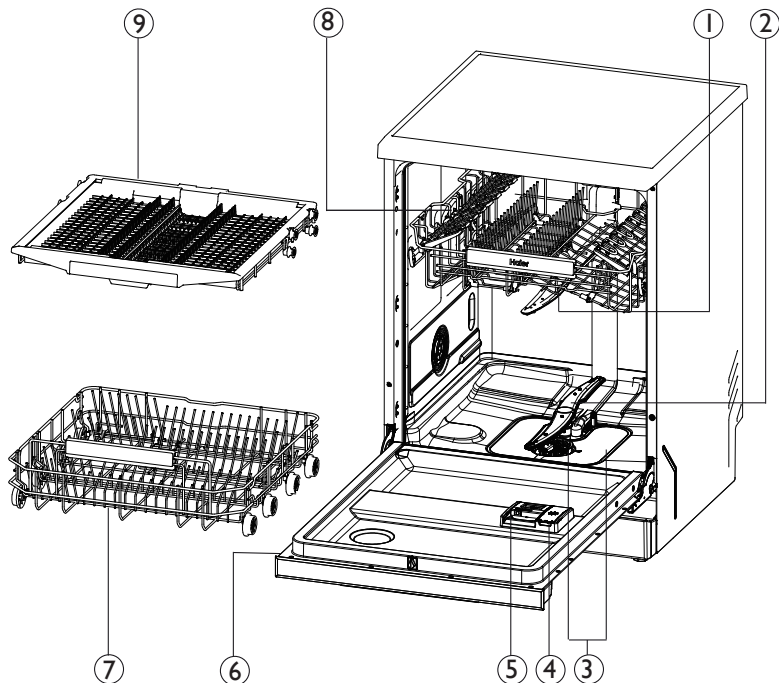

- |                        |                         |
|------------------------|-------------------------|
| 1. Upper spray arm     | 6. Rating label         |
| 2. Lower spray arm     | 7. Lower basket         |
| 3. Filter              | 8. Upper basket         |
| 4. Rinse aid dispenser | 9. Cutlery/Utensil tray |
| 5. Detergent dispenser |                         |

## Accessories

Check the accessories and literature in accordance with this list:



water inlet hose

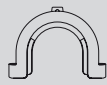

U-support



Warranty card



User manual

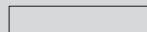

water-proof  
sticker



## Indicator Icon



Rinse aid

If the indicator lights up: Rinse aid is empty!  
After adding Rinse Aid, the indicator lights off.



Water tap

If the indicator lights up, The appliance does not fill with water. Check section: "TROUBLE SHOOTING"



Wi-Fi

If the indicator lights up, the dishwasher is successfully connected to the Wi-Fi.



Delay

If the indicator lights up, a delay start has been activated.

## Status Indicators



Wash

If the indicator is flashing: the Dishwasher is washing.



Rinse

If the indicator is flashing: the Dishwasher is rinsing.



Dry

If the indicator is flashing: the Dishwasher is drying.

## Optional function



Child Lock

To activate or cancel Child lock, Press and hold  until the Child lock indicator turn on or turn off.



Remote \*

Press the icon, and the app can start the dishwasher program.





Half load

Use this option if you have only a few items to wash. This will save water, energy and time. If you use powder detergent use a little less detergent than for a full load.

 Intensive + Prolong washing time and enhance washing effect.

 Steam + This function increases the temperatures and retains them for an extra long time to obtain a defined disinfection performance.

 Dry + In the last stage of rinsing, the washing temperature is increased and the drying time is prolonged to enhance the drying effect of tableware.

 Delay(+time) You can delay the start of a programme in 1 hour steps up to 24 hours.

 Delay(- time) When the  on, each press, the time is reduced 1h.

\* The "Remote" icon is half light before the dishwasher is connected to Wi-Fi. The "Remote" icon is full light after the dishwasher is connected to Wi-Fi. After pressing the "Remote" icon once, the mobile app can start the dishwasher program.

WASH PROGRAM	MODIFIER AVAIABLE
Auto	Dry+
Heavy	Steam +, Dry+, Intensive +, 1/2load
Medium	Steam +, Dry+, Intensive +, 1/2load
60min	Dry+, Intensive + , 1/2load
Eco	/
Glass	Dry+, 1/2load
Hygine	Dry+, Intensive + , 1/2load
Rinse	/

Programme	Type of food residue	Type of load
 1) Auto	Light to heavy soil: Casseroles, sauces, potatoes, pasta, rice, roasted or fried food	Non-delicate: Dinnerware, cutlery, pots and pans
 Heavy	Heavy soil: Casseroles, sauces, potatoes, pasta, rice, roasted or fried food	Non-delicate: Dinnerware, cutlery, pots and pans
 Medium	Daily soil: Soups, eggs, sauces, potatoes, pasta, rice, roasted or fried food	Non-delicate: Dinnerware, cutlery, pots and pans
 60 Min	Mixed soil: Coffee, cake, milk, cold drinks, salad, sausages, pasta, roasted or fried food	Non-delicate: Dinnerware, cutlery, pots and pans
 Eco	Normal soil: Soups, eggs, sauces, potatoes, pasta, rice, roasted or fried food	Non-delicate: Dinnerware, cutlery, glassware
 2) Glass	Light soil: Coffee, cake, milk, cold drinks, salad, sausages	Delicate: Glassware, dinnerware, cutlery
 Hygiene	Hygiene soil: Casseroles, sauces, potatoes, pasta, rice, roasted or fried food	Non-delicate: Dinnerware cutlery, pots and pans
 3) Rinse	Dishes to be stored for a few days before washing	All: Dinnerware, cutlery, glassware, pots and pans

1). The appliance senses the type of soil and the quantity of items in the baskets. It automatically adjusts the temperature and quantity of water, energy consumption and programme duration.

2). With this programme you can wash a load with fresh soil. It gives good washing results in a short time.

3). Use this programme to quickly rinse the dishes. This prevents the remaining food to bond on the dishes and bad odours to come out from the appliance. Do not use detergent with this programme!



## First Steps

Remove all packaging materials, keep them out of children's reach and dispose them in an environmentally friendly manner. There could be water residue inside the appliance due to quality checks in the factory.



Perform in the following steps:

1. Install the appliance.
  - ▶ Refer to section INSTALLATION.
2. Only for use of Multitabs: Adjust the rinse aid setting.
  - ▶ Refer to section DIFFERENT SETTINGS FOR RINSE AID.
3. Fill the rinse aid dispenser.
  - ▶ Refer to section HOW TO FILL THE RINSE AID DISPENSER.
4. Open the water tap.
5. Start any wash programme (apart from Rinse programme) with detergent but no load to remove possible manufacturing residues.

## Activate / De-Activate the Buzzer

An acoustic signal informs about the end of a programme. This signal can be switched off.

Refer to section HOW TO ADJUST SETTINGS and select the setting:

- ▶ If the display shows  the signal is switched off.
- ▶ If the display shows  the signal is switched on.

## Different Settings for Rinse Aid



Rinse aid is added during the last rinsing phase to dry the dishes without streaks and stains.

### Detergent (e.g. powder, tablets, ...)

- ▶ requires separate rinse aid:  
Factory default setting: . No settings are necessary.  
The rinse aid is added from the rinse aid dispenser only.

## Detergent with multifunction (e.g. Multitabs)

- ▶ combine detergent and rinse aid:

The rinse aid setting should be adjust to . Please use the setting instructions in section HOW TO ADJUST SETTINGS and select the -setting.

The rinse aid is added from the rinse aid dispenser in addition to the multitabs rinse aid.

Setting - cuts off the rinse aid dosage and the rinse aid indication. The higher the value for the higher the dosage.

Usually the recommended setting performs well. In case of streaks, stains, shimmer etc., refer to section TROUBLESHOOTING.

## How to fill the Rinse Aid Dispenser



### CAUTION!

Only use rinse aid for dishwashers.

Other products can cause damage to the appliance!

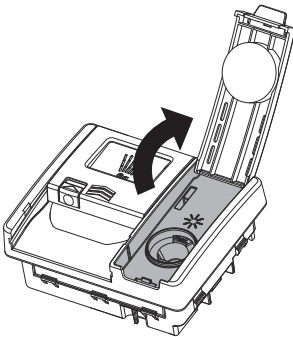

Lift the cover open and pour rinse aid into the opening.

Do not fill exceeding the MAX line.

Take care not to spill any onto the door or detergent bucket.

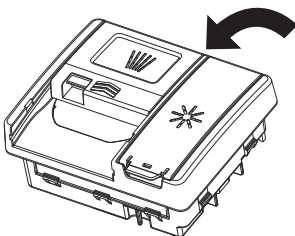

Close the cover, ensuring it clicks shut.

## Powder detergent quantity recommendations

Use the table below to determine the optimal powder detergent quantity for each wash programme.









If the water is hard in your area, more detergent may be required. Refer to 'Water Hardness' for more details

WASH PROGRAM	PRE WASH COMPARTMENT	MAIN WASH COMPARTMENT
Auto	None	1/2 - 2/3
Heavy	Full	2/3
Medium	Full	2/3
Hygiene	None	1/2
Eco	Full	2/3
60Min	Full	1/2
Rinse	n/a	n/a
Glass	Full	2/3











\* tablets are not recommended for the Hygiene cycle.

## How to Adjust Settings

### Adjust the Rinse Aid level



1. The appliance is switched on.
2. Press and hold  and  about 3 seconds until:
  - ▶ The display shows the current Rinse Aid setting (the default is ).
3. Press  to change the Rinse Aid setting in steps between  (minimum dispense, no rinse aid is set) and  (maximum dispense, represents putting in 6ml rinse aid).
4. Press  to save the option.
5. To exit the Rinse Aid menu, press and hold  for 1 second.

### Activate / De-Activate the Buzzer



1. The appliance is switched on.
2. Press and hold  and  for about 3 seconds until :
  - ▶ The display shows the current Rinse Aid setting.
3. Press  to scroll to the buzzer menu.
4. The display will show  (buzzer off) or  (buzzer on).
5. Press  to toggle between  (buzzer off) or  (buzzer on),
6. Press  to save the option.
7. To exit, press and hold  1 second.

### Child lock

This feature disables all the icons on the dishwasher. If any other icons are pressed while Child lock is activated, the Child lock indicator will flash for a few seconds.

1. To activate Child lock, press and hold  for 3 seconds.
2. The display will remain on (if no programme has been started it will continue to flash while the control panel is locked).
3. To cancel Child lock, press and hold  for 3 seconds.

## **Dishwasher operation**

1. Load the baskets.
2. Press the ON/OFF icon  to activate the appliance.
  - ▶ If the rinse aid indicator is on, fill the rinse aid dispenser and reset the rinse aid indicator ,refer to section HOW TO RESET THE RINSE AID IDNICATOR.
3. Add the detergent; refer to section DETERGENT.
4. Close the door.
5. Set the programme according to the type of load and how dirty the dishes, cups and cutlery are.
6. Maybe select a start delay time.
7. Press the START / PAUSE icon  to start the programme.
8. After programme end the appliance change to auto off. Unload the baskets.

## **How to Reset Rinse Aid Indicator**

The rinse aid indicator is on:

1. Always completely fill the rinse aid before starting the next wash cycle.
2. After adding Rinse Aid,the indicator lights off.

## Load the Baskets



With delicate glasses and porcelain make sure they are labelled dishwasher-proof.

- × Do not put in the appliance items made of wood, horn, aluminium, pewter and copper.
- × Do not put in the appliance items that can absorb water (sponges, household cloths).
- ▶ Only use the appliance to wash items that are dishwasher-safe.
- ▶ Remove remaining food from the items.
- ▶ Soften burned food on the items before washing.
- ▶ Put hollow items (cups, glasses and pans) with the opening down.
- ▶ Put items with deep hollows in a slanted position.
- ▶ Mix spoons with other cutlery to prevent them to bond together.
- ▶ Make sure that cutlery and dishes do not bond together and there is a gap between each item.
- ▶ Make sure that glasses do not touch other glasses.
- ▶ Put small items in the cutlery basket.
- ▶ Put light items in the upper basket. Make sure that the items do not move.
- ▶ Make sure that the spray arms can move freely before you start a programme.



If jingling noises are heard during a programme run: Check that the dishes and glassware have a firm position.

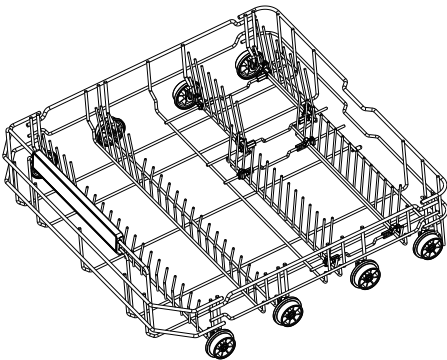

Place heavily soiled items (like pots and pans or dinner plates) in the bottom basket. The more powerful spray jet provides a better dishwashing result.

## Upper baskets

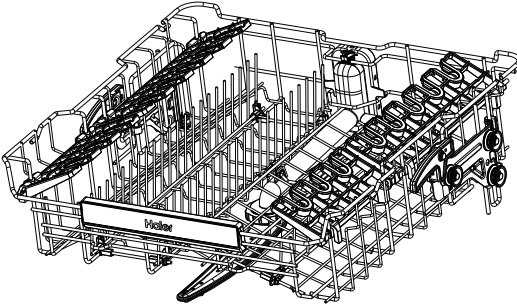

- ▶ The upper basket is designed to hold items like glasses, cups, saucers, plates, small bowls and shallow pans.

## Foldable cup racks

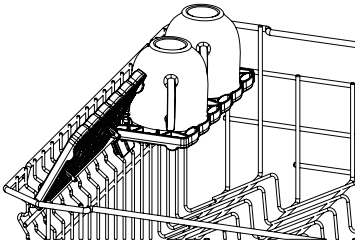

Adjust the height to suit or fold out of the way to make space for other items. Use the notches to support wine glass stems.

To adjust height

1. Fold up to unlock.
2. Adjust the height to suit by sliding up or down.
3. Fold back down to lock in position.

## Height adjustment of the upper basket.

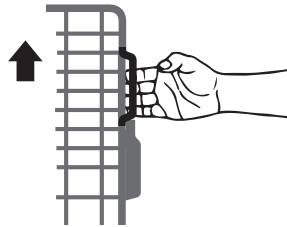
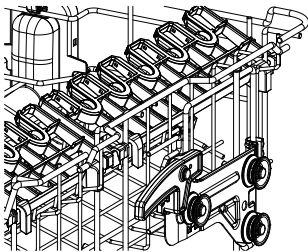

TO RAISE BASKET

Grip these handles both sides and lift basket upwards until it clicks in place.

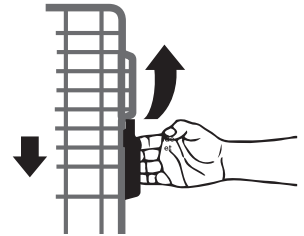

TO LOWER BASKET

Pull the levers up on both sides and carefully lower the basket.

## Foldable tine rack

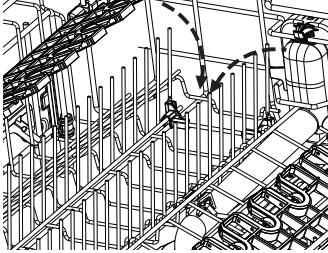

Some tines can be folded down as needed to make space for other items.

## Cutlery/Utensil tray

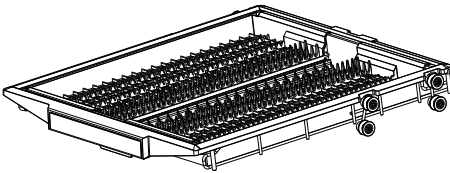

Use the tray to secure cutlery and utensils.

Place cutlery into the notches to secure.

Place larger utensils in the middle of the tray.

Slide side sections to the middle to create more space for items below.



## Detergent



Please use only a dedicated dishwasher detergent and follow the related instructions and dosage on its package.

### Using powder detergent

For powder detergent quantities, refer to the following 'Powder detergent quantity recommendations' table and the detergent manufacturer's guidance. No detergent is needed for RINSE.

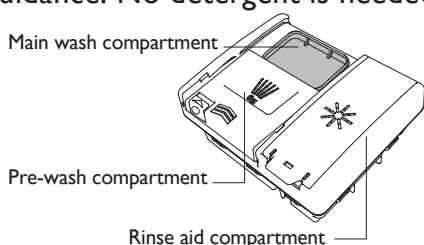

Check that the dispenser is empty and dry. Add powder detergent or tablets to the detergent dispenser.

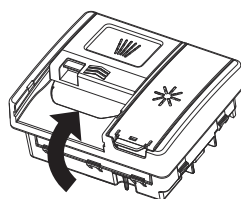

Remove any excess detergent then slide the cover closed. It will click into place. If required, add additional detergent to the pre-wash compartment on top of the dispenser.

When washing heavily soiled dishware in hard water, more detergent may be required. Refer to 'Powder detergent quantity recommendations'.

## Multitabs

These Multitabs detergent tablets could include two different agents for water softening, rinse aid and other functions. The softener and rinse aid setting must be adjusted according to section BEFORE FIRST USE. Usually the default setting performs well. If there are streaks, stains, shimmer etc., refer to section TROUBLESHOOTING and BEFORE FIRST USE.



Detergent tablets do not fully dissolve with short programmes. That may cause bad washing results and detergent residues.

If detergent without multifunction should be used again:

1. Save 3 to 5 tablets
2. Adjust the softener and rinse aid setting according to section BEFORE FIRST USE.
3. Use Multitabs detergent tablets for the next 3 to 5 wash cycles.

## Start a Programme

1. Close the door.
2. Press the ON/OFF icon .
3. Press the program icon you want to select and then the required programme indicator flashes.

Additionally the display shows the programme run-time.

4. If need select a start time for a delay start, refer to section START A PROGRAMME WITH DELAY.
5. Press the START/PAUSE icon  to activate the programme or the delay start.

The programme starts. The display acts now as countdown of the remaining run-time.



The appliance remembers the last programme you used. The next time the appliance is switched on, the appliance pre-selects the programme used last time.

## Interrupt a Running Programme

**To interrupt a running programme:**

- ▶ Press the START/PAUSE icon . The displayed cycle time is flashing.
- ▶ Open the door.

**To continue a paused programme:**

Close the door and press the icon  to continue the programme from the point of interruption. Long interval may cause bad cleaning results.



## Activate / Deactivate options

On some models, the combination of all options is possible with all programmes. You can set one option or combine all options.

1. Switch on the appliance.
2. press any illuminated icons to select the wash programme, The display shows the duration of the programme.
3. If needed, press any illuminated additional function icon and it can be matched with the current washing procedure.
4. Press the icon  to start the program.

## Start a Programme with Delay

Set a start time by the following procedure in order to delay a programme start:

1. Set a programme.
2. Press the reservation icon .
3. Press the START/PAUSE icon .
  - ▶ The display shows the countdown time of start. The count down decreases with steps of 1 hour. (from 1 to 24hours)
  - ▶ When the countdown is completed, the programme starts.

## Cancel the delay

When the current reservation time is displayed for 24:00, press the reservation  icon again to cancel the reservation.

When the reservation time is displayed for 1:00, press the reservation  icon to cancel the reservation.

## Cancel Start Delay Programme

Press the ON/OFF icon  for about 1 second.

- ▶ The start delay is cancelled.
- ▶ The programme is aborted.
- ▶ The appliance is switched off.

Start a new programme and a delayed start if needed.













### CAUTION!

If a programme will be aborted in the process of washing dishes, the residue of detergent remains on the dishes. These can cause damage to health! Make sure to rinse off the detergent residues completely before using these dishes again.



Make sure that there is detergent in the detergent dispenser before start a new programme.

## Automatic door opening setting

1. The appliance is switched on.
2. Press and hold  and  for about 3 seconds until :
  - ▶ The display shows the current Rinse Aid setting.
3. Press  to scroll to  .
4. Press  to toggle between  and  .
  -  - represents that the automatic door opening function is turned off.
  -  represents that the automatic door opening function is turned on.
5. Press  to save the option.
6. To exit, press and hold  1 second

Automatic door opening occurs in the drying stage. The time nodes of automatic door opening are different due to different washing procedures

## End of Programme

The door will open automatically before the program ends. When the programme is completed, the display shows END and the icon of the washing program and additional functions after running is on, the buzzer rings for 3 times, and standby after 2min without key operation. If the child lock is activated, the child lock will be cancelled while standby.



### CAUTION!

If the door will be opened immediately after the end of programme, hot steam can escape. Danger of scalding! Open the door carefully!

## Standby Mode

The switched on appliance will go into standby mode if it is not activated within 2 minutes before starting a programme, or at the end of a programme. This saves energy. The display switches off.

Your appliance can be connected to your home wireless network and Selected remotely using the app.

## Getting started

Ensure your home Wi-Fi network is turned on.

You will be given step by step guidance on both your appliance and mobile device. It may take up to 10 minutes to connect your appliance.

For further guidance and troubleshooting, please refer to the app.

## On your mobile device:

1. Download the app from:

Australia <https://www.haier.com.au/smart>

New Zealand <https://www.haier.co.nz/smart>

2. Register and create an account.

3. Add your appliance and set up the Wi-Fi connection.

## Connecting to your home Wi-Fi

With the product in standby (Screen is off):

Press and hold  for 5 seconds, the display will show APP.

You can now, follow the prompts in the app to complete set-up.

## Enabling Remote mode

1. When the machine is not connected with app, the "Remote" icon is half light.

When the machine is connected with app, the "Remote" icon is full light.

2. "Remote" icon can only be selected before the cycle start. "Remote" icon can be cancelled at any time.

3. After pressing the "remote" icon once, the mobile app can start the dishwasher program. You can control the dishwasher by app, such as: select a cycle, cancel or pause a cycle, add the additional functions.

## Cleaning the filter, spray arms and filter plate

Disconnect the dishwasher from the power supply and allow it to cool before undertaking any cleaning or maintenance.

We recommend that the drain filter and filter plate are removed and cleaned once a month or whenever there is evidence of food particles. The spray arms in normal use should require cleaning less frequently. Lower and upper spray arms can be shaken to remove any foreign material, cleaned in hot water, then rinsed in clean water.

The dishwasher must be used with the filter plate, drain filter and spray arms correctly in place. If using a dishwasher cleaner or descaler, refer to manufacturer instructions.

## Care and Cleaning the Filters

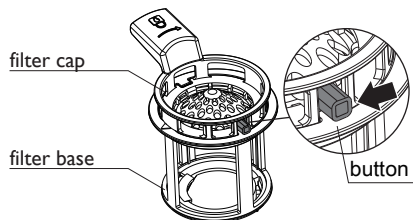

Twist the filter anti-clockwise to release. Lift to remove.

Separate the filter cap from the base by pressing the release buttons and lifting.

Do not attempt to remove the filter by force as this may cause damage.

Clean under hot water and rinse thoroughly.

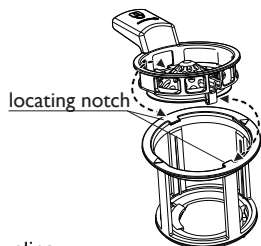

## Replacing the filter

1. Align the filter cap with the notch on the filter base for one side.
2. Press the button to settle the filter cap on the filter base for the other side.
3. Slot the filter plate under the locating clips at the rear of the drain and push firmly back into place. Ensure the filter plate is flush with the dishwasher base.
4. Place the drain filter back into the dishwasher base. Rotate clockwise to click into place.



An incorrect assembly or position of filters will cause bad washing results and possibly serious damage to the appliance.

If any filter is removed make sure that no solid object of any size is left beyond these filters!

## Care and Cleaning of the Spray Arms

Spray arms should be regularly inspected for dirt. If needed the spray arms could be removed.

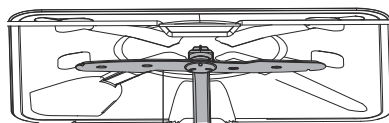

top spray arm

Do not remove the top spray arm for cleaning.

Clean with a small, plastic-bristled brush. If heavily soiled or blocked use a dishwasher cleaner/descaler. Follow the manufacturer's instructions.

## Cleaning the Upper spray arm

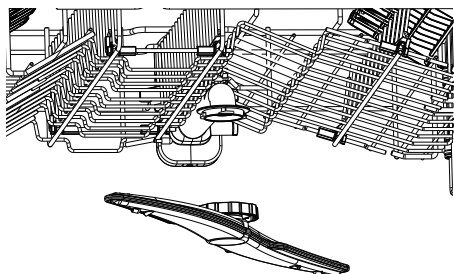

To remove the upper spray arm, turn the locking nut clockwise to release. Rinse the spray arm thoroughly under running water, then refit.

## Cleaning the lower spray arm

To remove the lower spray arm, lift it from the base of the dishwasher. Rinse the spray arm thoroughly under running water, then refit. Ensure the arm rotates freely when refitted.

## External Cleaning



### CAUTION!

Never clean the appliance with a steam cleaner.

Never use bleach or other chlorinated detergents.

- ▶ Clean the appliance with a damp soft cloth.
- ▶ Only use neutral detergents. Do not use abrasive products, abrasive cleaning pads or solvents.
- ▶ Clean the door seal with a damp soft cloth.

Many occurring problems could be solved by yourself without specific expertise. In case of a problem please check all shown possibilities and follow below instructions before you contact an after sales service



## CAUTION!

- ▶ Before maintenance, deactivate the appliance and disconnect the power plug from the power socket.
- ▶ Electrical equipment should be serviced only by qualified electrical experts, because improper repairs can cause considerable consequential damages.

## The appliance does not start, or it stops during operation

Problem	Possible cause	Possible solution
The programme does not start.	Appliance door is open.	Close the appliance door.
	Delay start is set.	Refer to displayed time.
	Power plug is not connected in the power socket.	Connect the power plug.
	Fuse in the house circuit is damaged.	Replace the fuse.
Rinse Aid Indicator  is light.	Rinse aid dispenser is empty.	Refill Rinse aid until full.

## Error codes on the display

Acoustic alarm, display shows ALARM CODE <i>A10</i> The appliance does not fill with water.	Water tap is closed.	<ul style="list-style-type: none"> <li>• Open the water tap.</li> </ul> <b>Note:</b> Whenever Error 'A10' is solved switch off the appliance and restart the programm.
	Water inlet hose has a kink or a bend.	Make sure that the position of the hose is correct.
	In case of aqua-stop system: water protection is triggered; the marker (C) is red.	The hose must be replaced.
	Filter in the water inlet hose is clogged.	Clean the filter at the inlet hose connections at tap and the rear of the appliance.
	Water inlet is clogged.	Check water flow from tap.
	Water pressure is too low.	Contact your local water authority.



Problem	Possible cause	Possible solution
Acoustic alarm, display shows ALARMCODE F30 Leak: The drain pump runs permanently!	<ul style="list-style-type: none"> <li>Anti-flood device is on:</li> <li>There are water leakages in the appliance.</li> <li>The water inlet valve is open and blocked.</li> <li>The drainage is blocked.</li> </ul>	<ul style="list-style-type: none"> <li>Close the water tap.</li> <li>Disconnect appliance from power supply.</li> <li>Contact Service.</li> </ul>

## Washing Results are not satisfactory

The dishes are not clean.	Filters are clogged.	Clean the filters.
	Filters are not correctly assembled and installed.	Make sure that the filters are correctly assembled and installed.
	Spray arms are clogged.	Remove remaining food remnants with a thin pointed object.
	Programme was not applicable for the type of load and food remnants.	Make sure that the programme is applicable for the type of load and food remnants.
	Incorrect position of the items in the baskets. Water could not wash all items.	Make sure that the position of the items in the baskets is correct and that the water can easily wash all items.
	Spray arms could not turn freely.	Make sure that the position of the items in the baskets is correct and does not cause the blockage of the spray arms.
	No detergent or insufficient quantity of detergent in the detergent dispenser.	Make sure that you add the correct quantity detergent in the dispenser before you start a programme.
	The wash cycle was interrupted by a long break.	Do not open the door or cut power supply during the wash cycle.
Whitish streaks, stains or bluish layers on glasses and dishes.	Released quantity of rinse aid is too much.	Decrease the released quantity of rinse aid. Refer to section DIFFERENT SETTINGS FOR RINSE AID.
	Quantity of detergent was too much.	Make sure that you add the correct quantity of detergent in the dispenser before you start a programme.
	Multitab detergent tablets used with a short programme might not fully dissolve.	Select a longer programme when using Multitab detergent tablets

Problem	Possible cause	Possible solution
Dry water drop stains on glasses and dishes.	Rinse aid dosage is too low.	Increase the released quantity of rinse aid. Refer to section DIFFERENT SETTINGS FOR RINSE AID.
	Quality of rinse aid or Multitab.	Cleaning product too old, change the product.
The dishes are wet.	<ul style="list-style-type: none"> <li>• Programme had no drying phase.</li> <li>• Programme had a low temperature drying phase.</li> </ul>	Open the door slightly and leave it ajar (about 100 mm) to help the drying process.
The dishes are wet and matte.	Rinse aid dispenser is empty.	Refill rinse aid into the dispenser and reset the rinse aid indicator.
	Quality of rinse aid or Multitab.	Cleaning product too old; change the product.



## Economic and Environmental Use

- ▶ It is not recommended to pre-rinse the dishes under running water.
- ▶ Select the washing programmes by type and degree of contamination of the dishes.
- ▶ Select the economic mode programme ECO for normal soiled items.
- ▶ The most economically use you will have with full loading.
- ▶ Only use the manufacturer's recommended detergent or rinse aid dosages.

Wash programme	Eco When the programme is finished, open the door to help with drying
Powder detergent quantities	5g pre-wash+28.75 g main wash
Rinse aid dosage level	d5
Maximum number of place settings	15
Height adjustment of upper basket	Ensure the upper basket is in its lower most position

## Recommended loading patterns

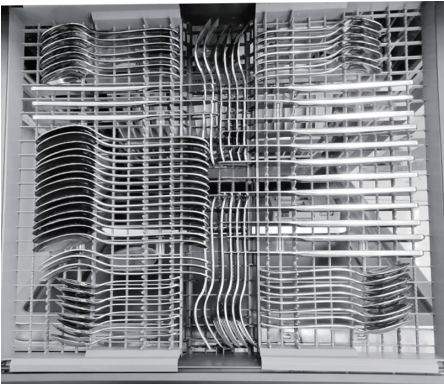

Cutlery/Utensil tray



Upper basket

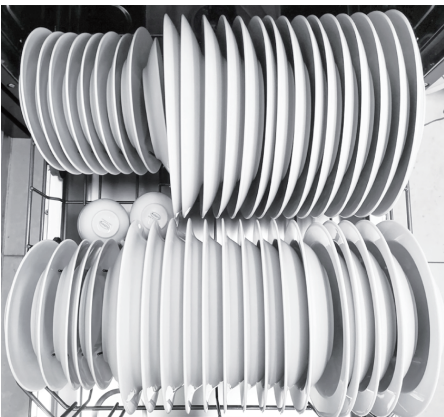

Lower basket

We recommend our Haier Customer Service and the use of original spare parts.

If you have a problem with your appliance, please first check TROUBLESHOOTING.

If you cannot find a solution there, please contact:

- ▶ Your local dealer.
- ▶ The Service & Support area at [www.haier.com.au](http://www.haier.com.au)  
or at [www.haier.co.nz](http://www.haier.co.nz)

where you can activate the service claim and also find FAQs.

To contact our Service, ensure that you have the following data available. The information can be found on the rating plate at the door.

Model \_\_\_\_\_

Serial No. \_\_\_\_\_









条形码尺寸40\*8mm，由厂家生成。

0120505524