

User manual  
Heat-Pump-Dryer

HDHP90NW1  
HDHP90NB1

NZ AU

**Haier**

## Thank you for purchasing a Haier Product.

Please read these instructions carefully before using this appliance. The instructions contain important information which will help you get the best out of the appliance and ensure safe and proper installation, use and maintenance.

Keep this manual in a convenient place so you can always refer to it for the safe and proper use of the appliance.

If you sell the appliance, give it away, or leave it behind when you move house, make sure you also pass this manual so that the new owner can become familiar with the appliance and safety warnings.

### Legend



**Warning!** – Important safety information



Environmental information



Warning: Risk of fire/Flammable materials



Read the instructions



General information and tips



## Disposal

Help protect the environment and human health. Put the packaging in applicable containers to recycle it.

Help to recycle waste of electrical and electronic appliances. Do not dispose appliances marked with this symbol with the household waste. Return the product to your local recycling facility or contact your municipal office.



### **WARNING!**

**This appliance contains R290. Flammable material, risk of fire.**

**WARNING:** Make sure the ventilation paths inside the appliance are not blocked.

**WARNING:** Do not damage the refrigerant circuit.



### **WARNING!**

#### **Risk of injury or suffocation!**

To ensure safety when disposing of an old tumble dryer, disconnect the mains plug from the socket, cut the mains power cable and destroy this together with the plug. To prevent children shutting themselves in the machine, break the door hinges or the door lock.



### **WARNING!**

The appliance must not be powered through an external switching device, such as a timer, or connected to a circuit that is regularly switched on and off by a utility.

1-Safety information..... 4

2-Product description ..... 9

3-Control panel..... 10

4-Cycle..... 15

5-Suggestions and tips..... 17

6-Daily use..... 19

7-Care and cleaning..... 23

8-Troubleshooting..... 25

9-Installation..... 27

10-Customer Service.....32

Before switching on your appliance for the first time, read and save this guide.



## **WARNING!**

### **Meaning of symbols on the dryer**



Warning: Risk of fire/Flammable materials



Read the instructions

### **Before First Use**

- Do not operate this machine if it has been damaged during transport. Contact your dealer or Haier service technician.
- Ensure all transport bolts are removed before running the appliance. Failure to do so might end in damage to the appliance.
- Remove all packaging and keep out of reach of children.
- This appliance is heavy, we recommend 2 people to move and install the appliance.
- This product has been designed for personal, family or household use. This product is not designed for any commercial use. Any commercial use will terminate this product's manufacturer's warranty.

### **Daily use**

- This appliance is not intended for use by persons (including children) with reduced physical, sensory or mental capabilities, or lack of experience and knowledge, unless they are supervised or given instructions on how to use it by someone responsible for their safety.
- Supervise children to ensure they do not play with the appliance or climb inside the drum.
- Do not swing on or put weight on the door.
- The appliance should only be used for garments recommended for machine drying. Always follow the advice on the care label.
- Do not touch or operate the machine with wet hands or with bare-feet.
- Do not place dripping wet clothing in or on top of the appliance as it may create an electrical hazard.
- Do not use the appliance if industrial chemicals (e.g. solvents) have been used on the clothes.
- Remove all items such as lighters and matches from pockets.
- Pull up zips, fix loose threads and protect embellishments to prevent garments from being damaged and entangled.
- Garments that contain metal reinforcements should not be placed in the appliance. If necessary, use an appropriate laundry bag or net.

**WARNING!****Daily use**

- The appliance might get hot during operation, use caution if in close proximity.
- Unplug the appliance before undertaking maintenance. Hold the plug (not the cable) when unplugging the machine.
- Ensure there are no undesirable objects inside the drum before starting a cycle.
- Ensure that the ambient temperature is between 5°C and 35°C before using the appliance.

**Intended use**

- This appliance is intended for drying garments that can be tumbled.
- Follow the manufacturer instructions found on the garment label.
- Do not make any changes or modifications to this appliance, they might cause personal injury and damages to property.
- Do not install the appliance behind a lockable door, sliding door, or behind a door where the hinge is on the opposite side to that of the dryer in such a way that the full opening of the door is inhibited. Ensure the dryer door can always be opened fully.
- If installed behind a cabinetry door, it must be hinged on the same side as the dryer with a minimum clearance of 30mm from the dryer handle to the internal surface of the cabinetry door. The cabinetry door must remain open while the machine is running.
- Exhaust air must not be discharged into a flue which is used for exhausting fumes from appliances burning gas or other fuels.

**Capacity**

- Do not overload the appliance beyond its rated capacity:  
MAXIMUM DRY CAPACITY: 9 Kg
- Capacity refers to the maximum dry weight of items the appliance can dry at any one time

**Dryer Information**

- Ensure all lint filters are cleaned before every load.
- Do not operate this product without the lint filter in place or allow lint to accumulate in or around the appliance.
- If the lint filter is damaged, contact your Haier service technician to arrange getting a new filter. Do not operate your appliance with a damaged lint filter or without the filter in place, as this will cause damage to your appliance.



## WARNING!

### Dryer Information

- If ducting the dryer to the outdoors, ensure adequate ventilation is provided during operation of the appliance to avoid any backflow of gases from fuel burning appliances.
- WARNING: The last stage of the drying cycle is a cool down phase. Never stop a tumble clothes appliance before the end of the cycle unless all items are removed and spread out in order to dissipate the heat.
- Do not dry Items which are unwashed.
- Do not dry items which have been cleaned with industrial chemicals. Items that have previously been cleaned in, washed in, soaked in or spotted with flammable liquids or solids, eg petrol/gasoline, kerosene, dry cleaning solvents, vegetable or cooking oil, acetone, denatured alcohol, some brands of spot removers, turpentine, waxes and wax removers or other flammable or explosive substances should not be placed in a tumble dryer.
- Rubber backed articles, foam rubber (latex foam), clothes or pillows fitted with foam rubber pads, fibreglass, shoes containing rubber, plastic, shower caps, babies waterproof napkin covers and waterproof textiles should not be dried in the dryer. These materials when heated can produce fire by spontaneous combustion.
- Do not dry an electric blanket or any other electrical items in your dryer, unless the care label specifically states it is safe to do so. Never dry these items at high temperatures.
- Fabric Softeners or similar products should not be used in a tumble dryer to eliminate the effects of static electricity, unless this practice is specifically recommended by the manufacturer of the fabric softener product.
- Oil-affected items can ignite spontaneously, especially when exposed to heat sources such as a tumble appliance. The items become warm causing an oxidation reaction in the oil. This oxidation creates heat. If the heat cannot escape, the items can become hot enough to catch fire. Piling, stacking or storing oil-affected items can prevent heat from escaping and create a risk of fire hazard.
- If it is unavoidable that fabrics that contain vegetable oil, cooking oil or have been contaminated by hair care products be placed in the appliance, they should first be washed in hot water with extra detergent – this will reduce, but not eliminate the fire hazard. The cool down cycle of the appliance should be used to reduce the temperature of these items. They should not be removed from the tumble appliance and piled or stacked while hot.

**WARNING!****Maintenance, Cleaning and Disposal**

- Keep the gasket, dispenser and door clean to prevent odours.
- Do not use water spray or steam to clean the appliance.
- A damaged electrical cable must be replaced by a Haier service technician or similarly qualified person. Do not use the appliance until it has been repaired to avoid a risk of electric shock.
- The only user-removable parts of the appliance are the lint filter and the condenser filter. No other parts are designed to be removed by the user.
- When disposing of the appliance, it is recommended that the door is removed to avoid children getting trapped inside, and that the electrical cable is cut off close to the machine.
- Unless the product is modified by an certified technician, any changes might result in loss of warranty.

**Installation****WARNING! Electric Shock Hazard! Failure to follow this advice may result in electric shock or death.**

- Ensure that the appliance cable is positioned so that it does not come into contact with water or moisture.
- The appliance must not be supplied through an external switching device, such as a timer, or connected to a circuit that is regularly switched on and off by a utility.
- Install the appliance in a well-ventilated, dust-free environment.
- This appliance must not be installed or operated on a plinth (other than a genuine Haier part, installed per the instructions).
- We do not recommend the use of extension cords or portable electrical outlet devices.
- Ensure the installation provides accessibility to the plug or incorporate a switch in the fixed wiring in accordance with the wiring rules to allow disconnection of the appliance from the supply after installation.
- Review the electrical information on the rating plate before plugging in this appliance to make sure the right voltage and current can be supplied.
- Install the appliance on a solid and level surface ensuring it has 20mm clearance on each side. The appliance must not be installed on any textured floor coverings (e.g. carpet, rugs).
- We recommend to replace the inlet hoses (if any) every 5 years.



## WARNING!

### Installation

- A stacking kit **MUST BE USED** between the products and fitted correctly to the washing machine and dryer as per stacking kit instructions.
- Ensure you use the compatible stacking kit for your washer and dryer combination.
- Stacking kits are available through your Haier Brand dealer or online
- Ensure that the power plug is always accessible.
- The following stacking configurations are not safe and **MUST NOT** be used:
  - A washer stacking on top of a dryer.
  - A washer on top of a washer.
  - An incompatible washer/dryer/stacking kit combination.
  - **WARNING:** Failure to do so may result in a flood and damage to property.
  - Do not expose the appliance to frost, external heat sources or direct sunlight.
  - Do not install the appliance in a location where the ambient temperature drops below 5°C.
  - Do not install the appliance outdoors or in a damp location.

### Water supply requirements:

- Inlet water pressure: Max. 1MPa (145psi), Min. 30kPa (44.5psi)
- Inlet water flow rate: Min. 6 litres/minute
- Cold water temp: Max 35°C
- A pressure-reducing valve must be installed if pressure is higher than 1Mpa
- New hose sets provided should be used to connect the appliance to the water mains. Old hose sets should not be re-used.
- We recommend the inlet hose(s) are changed every 5 years. **WARNING:** Failure to do so may result in a flood and damage to property.
- The cold water temperature should not exceed 35°C. Temperatures above these may cause the appliance to fault or cause damage to it.



### Notice

The appliance contains the fluorinated greenhouse gas **R290**. This gas is hermetically sealed.





**Note:**

Due to technical changes and different models, the illustrations in the following chapters may differ from your model.

## 2.1 Picture of appliance

Front (Fig. 2-1):

Rear side (Fig. 2-2):



- 1 Water tank
- 2 Tumble dryer door
- 3 Control panel

- 4 Power supply cord
- 5 Back panel
- 6 Drainage outlet
- 7 Adjustable feet

## 2.2 Accessories

Check the accessories and literature in accordance with this list (Fig.2-3):

2-3



Drain hose

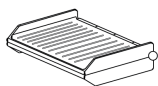

Drying rack



Inlet hose



Adapter



Warranty cards



User manual

# 3-Control panel

NZ AU

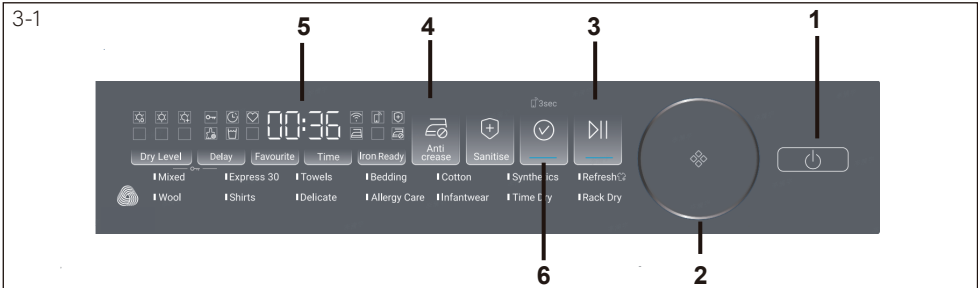

1 Power button  
2 Dial

3 Start/Pause button  
4 Function buttons

5 Display  
6 Confirm button

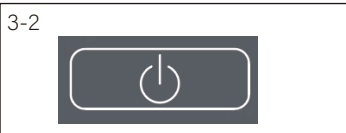

### 3.1 Power button

Long press the button (Fig. 3-2) to turn on or turn off the machine. When the machine is turned on, the Confirm button will start flashing. No operation on the machine for more than 2 minutes, the machine will be turned off automatically. When the machine is turned off, long press the Power button for 5 seconds, "APP" will be displayed on the screen, and the Wifi icon  will start flashing, it means the machine has activated Wifi provisioning mode.



### 3.2 Dial

Turn the dial to select a cycle. The cycle will be flashing when selected, and its default settings will also light up.



### 3.3 Confirm button

Short press to confirm your selection before start the cycle. Long press for 3 seconds, the icon  will flash, then press the Start/Pause button to activate the Remote mode.

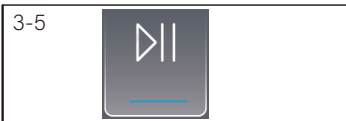

### 3.4 Start/Pause button

Press this button (Fig. 3-5) to start or pause a cycle. When the cycle is paused, the Confirm button will be flashing. To restart the cycle, users need to press the Confirm button first, then press the Start/Pause button.

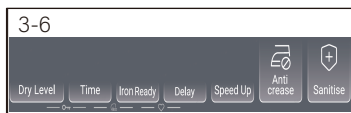

### 3.5 Function buttons

The seven buttons (Fig.3-6) are function buttons, which can be selected as required.

### 3.5.1 Dry level button

Press this button (Fig. 3-7) to adjust the dry level: there are totally 3 levels as listed below (Fig. 3-8). This function is not available for Express 30/Wool/Refresh/Time Dry/Allergy Care/ Rack Dry cycles.

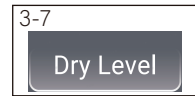

### 3.5.2 Time button

This function button (Fig. 3-9) is designed for users to adjust duration of specific cycles including Time Dry/Wool/Rack Dry.

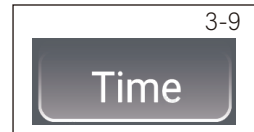

### 3.5.3 Iron Ready button

Press this button (Fig. 3-10) to set the iron ready reminder. After activated, the icon  will light up. And when the garments reach the moisture content level that is most suitable for ironing, the machine will sound a 2-minute prompt tone to remind user.

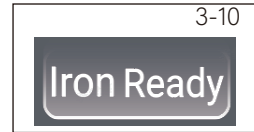

### 3.5.4 Delay button

Press this button (Fig. 3-11) to set the delay time from 1 hour to 12 hours with 1-hour increment. After selection, press the Confirm button and Start/Pause button, the icon  will light up. This function is not available on Refresh cycle.

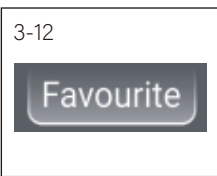
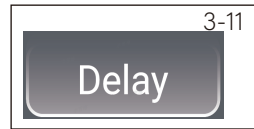

### 3.5.5 Favorite button

Select a cycle and preferred settings, then press this button (Fig. 3-12) for 3 seconds, the icon  will light up, then the preferred settings will be saved by the product. Next time users select this cycle, preferred settings will be automatically selected.

Press these 2 buttons simultaneously for 3 seconds, this cycle will recover to its default settings.

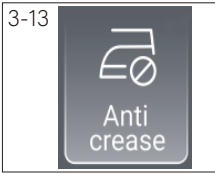

### 3.5.6 Anti crease button

If the garments aren't taken out timely after the end of the cycle, wrinkles may occur on them. This function (Fig. 3-13) can help to prevent this issue. When activated, the icon  will light up, and after the end of the cycle, the drum will keep rotating for 1-12 more hours with cold air blowing in. This function is not available on Synthetics/Express 30/Rack Dry/Refresh/Wool cycles.

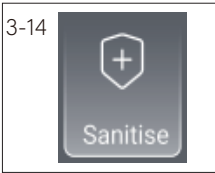

### 3.5.7 Sanitise button

This function is designed to kill bacteria and mites with high temperature. When activated, the icon  will light up, and the drying time will increase by 120 minutes. This function is only available on Mixed/Towels/Bedding/Cotton/Duvet/Bulky/Allergy Care cycles. For Allergy Care cycle, this function is on by default.

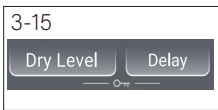

### 3.5.8 Keylock button

When the cycle is running, press the 2 buttons (Fig. 3-15) simultaneously for 3 seconds to activate Keylock function, then the icon  will light up. Deactivate this function with same method.

## 3.6 Display

The display (Fig.3-16) shows following information:

- ▶ Function information
- ▶ Remaining time
- ▶ Other related information
- ▶ Error codes and service information



### **i** Notice:

For Timed cycles, including Time Dry, Rack Dry, Refresh, Express 30, Wool, the remaining time is a default value. For other Auto cycles, at first, screen will display "AUTO", then the remaining time will be calculated based on cycle settings, load size and moisture content level, etc.

### 3.7 functions



Keylock function



Delay function



Favourite function



Clean filter function



Empty tank function



Wifi function



Remote function



Sanitise function



Iron Ready function



Anti-crease function

#### 3.7.1 Clean filter icon

This indicator is designed to remind users to clean filter before using. When this icon (Fig. 3-17) lights up, users should clean the filter before use. For the cleaning method, please refer to the Lint filter cleaning or Condenser filter cleaning section of this manual.



#### 3.7.2 Empty tank icon

When this icon (Fig. 3-18) lights up, recommend to empty the water tank.

Important: recommend to empty the water tank after each cycle, for specific steps, please refer to the Water tank section of the manual.



#### 3.7.3 Wifi icon

During the Wifi provisioning process, the icon (Fig. 3-19) will be flashing (0.5s On, 0.5s Off), when completed, the icon will remain On.



<b>Cycle</b>	<b>Description</b>	<b>Max Recommended Capacity(kg)</b>	<b>Default Dryness Level</b>
Mixed	Autosensing cycle for loads with different types of clothes and fabrics.	9	Cupboard
Express 30	Fast fixed time cycle to dry small loads of light garments.	-	-
Towels	Autosensing cycle designed to dry thick, durable and absorbent items such as towels	5	Cupboard
Bedding	Autosensing cycle with a reverse pattern designed to dry bed sheets.	5	Cupboard
Cotton	Autosensing cycle for garments made of cotton fabrics.	5	Cupboard
Synthetics	Autosensing cycle for garments made with synthetic fabrics or synthetic blends	4	Ready to wear
Refresh	Timed cycle designed to Care of dry clothing with spray.	-	-
Wool	Timed cycle for wool that can be tumbled dry.	-	-
Shirts	Autosensing cycle for shirts that can be tumbled dry.	2.5	Ready to wear
Delicate	Gentle autosensing cycle for delicate garments.	2.5	Ready to wear
Allergy Care	Autosensing cycle that uses longer drying time to achieve the effect of eliminating bacteria and mites.	3	Cupboard
Infantwear	Autosensing cycle which is used to dry heat-resistant infant wear made of cotton.	3	Cupboard
Time Dry	Timed cycle that uses hot air to dry garments.	-	-
Rack Dry	Timed cycle for clothes that need to be placed on rack for drying.	-	-

#### 4.1 Registration Cycle

Mixed, Dry level, Dry, is the recommended energy saving cycle for everyday drying. Check the energy label for energy consumption information. The actual energy consumption may differ from the declared one according to local conditions.

#### 4.2 Refresh Cycle

This cycle is designed to help to remove odor, dust, wrinkle and light moisture. Please make sure the product is connected to the mains water before each use. If the garments are damp, it is recommended to dry it before using the Refresh cycle.

#### 4.3 Wool clothing washing and care

The wool drying cycle of this machine has been tested and approved by The Woolark Company. The cycle is suitable to dry wool garments which are labelled "hand wash" provided that the garments are washed in a Woolmark endorsed hand washing cycle and dried according to the instructions issued by the manufacturer of this machine.M2443.



## 4.4 Wi-Fi Connection

### 4.4.1 Getting started

Ensure your home Wi-Fi network is turned on.

You will be given step by step guidance on both your appliance and mobile device.

It may take up to 10 minutes to connect your appliance.

### 4.4.2 On your mobile device

1. Your product is Wi-Fi connectable. Please visit the webpage below to download the app and find out more:

Australia <https://www.haier.com.au/smart>;

New Zealand <https://www.haier.co.nz/smart>;

2. Register and create an account.

3. Add your appliance and set up the Wi-Fi connection.

### 4.4.3 Connecting to your home Wi-Fi

To provision the product for Wi-Fi connection: Press and hold the Power button for five seconds until the "APP" is displayed on the screen and the icon  is flashing. Follow the instructions in the App to get your appliance connected.

### 4.4.4 Remote Mode

Press Remote button to turn ON and OFF the Remote Mode function.

When the Remote Mode is ON, the appliance can be controlled by the Smart HQ App for your convenience.

Not all functions will be available through the App.



## 5.1 Starched laundry

Starched laundry leaves a film of starch in the drum and is not suitable for the dryer.

## 5.2 Softener

Do not use softener when washing, because the laundry will become soft and fluffy in the dryer.

## 5.3 Soft care cloths

The use of "soft care cloths" can lead to a coating at the lint filters. This can cause a blockage of the filters. In such cases, we recommend either to avoid adding soft care cloths or to choose a different brand. In any case note the manufacturer's instructions

## 5.4 Small amounts of filling

When the load is less than 1.0kg, the Time Dry cycle should be selected, because sometimes it may not be able to sense the dryness level of the clothes when the load is too small.

## 5.5 Drum interior light

When the appliance is switched on, the drum light will keep on when the door is open.

## 5.6 Service flap

Make sure that the service flap is always closed during operation.

## 5.7 Anti crease protection

At the end of the cycle, if the laundry is not taken out, the drum may rotate from time to time to prevent creases.

## 5.8 Remaining time

The cycle duration is influenced by the following factors: the type of fabric, the load size, moisture content, the desired dry level, as well as the spin speed during drying. These factors are registered by the electronics during the cycle and the remaining time will be corrected accordingly.

## 5.9 Extra large pieces

When cycle ends, if the desired dry level is not achieved, loosen up the laundry and dry again with the Time Dry cycle.

## 5.10 Especially delicate fabrics

Textiles which can easily shrink or lose their shape, as well as silk stockings, lingerie should not be put in the dryer directly. Put delicate garments inside a laundry bag and avoid over-drying them.

## 5.11 Jersey and knitwear

Clothes like jersey and knitwear, we recommend to use Delicate cycle to dry to avoid over-drying.

## 5.12 Flipping clothes

It is recommended to close the zipper and flip it inside and outside before operation to avoid over-drying.

## 5.13 Metal ornament























If metal decorations and plastic nail beads are used on the clothing, it should be properly wrapped to avoid hitting the drum and causing damage before operation.

## 5.14 Acoustic signal

An acoustic signal can be activated:

- ▶ When the water tank is full.
- ▶ Failures happen.

## Care chart

Washing		
 Washable up to 95°C normal process	 Washable up to 60°C normal process	 Washable up to 60°C mild process
 Washable up to 40°C normal process	 Washable up to 40°C mild process	 Washable up to 40°C very mild process
 Washable up to 30°C normal process	 Washable up to 30°C mild process	 Washable up to 30°C very mild process
 Wash by hand max. 40°C	 Do not wash	
Bleaching		
 Any bleaching allowed	 Only oxygen/ non-chlorine	 Do not bleach
Drying		
 Tumble drying possible normal temperature	 Tumble drying possible lower temperature	 Do not tumble dry
 Line drying	 Flat drying	
Ironing		
 Iron at a maximum temperature up to 200 °C	 Iron at a moderate temperature up to 150°C	 Iron at a low temperature up to 110 °C; without steam (steam ironing may cause irreversible damage)
 Do not iron		

**6.1 Prepare the appliance**

1. Connect the appliance to a power supply (220V to 240V~/50Hz) (Fig.6-1). Please also refer to section INSTALLATION.
2. Make sure:
  - ▶ The water tank is empty and properly installed. (Fig.6-2).
  - ▶ The lint filter is clean and properly installed. (Fig.6-3).
  - ▶ The condenser filter is clean and properly installed (Fig.6-4).

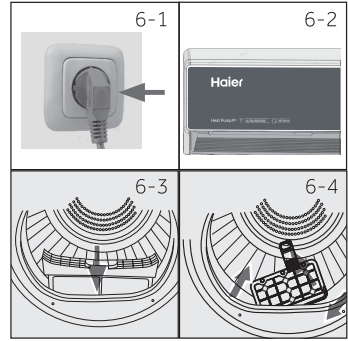

**6.2 Prepare the laundry**

- ▶ Sort clothes according to fabric (cotton, synthetics, wool etc.). Only dry clothes that has been spun.
- ▶ Empty pockets of all sharp or flammable objects such as keys, lighters and matches. Remove hard decorative objects such as brooches.
- ▶ Zippers up and make sure the buttons are sewn on tightly and place small items such as socks, bras etc. in a wash bag.
- ▶ Unfold bulky items of fabric such as bed sheets, table cloth etc.
- ▶ Follow the instructions on the laundry label and dry those garments that can be dried by machine.

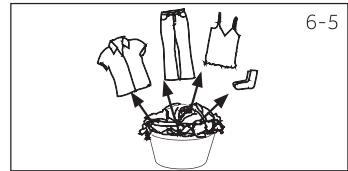

Load Reference	Composition	Average weight per item
Bed sheet (single)	Cotton	Approx. 800 g
Blended fabric clothes	/	Approx. 800 g
Jackets	Cotton	Approx. 800 g
Jeans	/	Approx. 800 g
Overalls	Cotton	Approx. 950 g
Pyjamas	/	Approx. 200 g
Shirts	/	Approx. 300 g
Socks	Blended fabrics	Approx. 50 g
T-Shirts	Cotton	Approx. 300 g
Underwear	Blended fabrics	Approx. 70 g

## Tips:

- ▶ Separate white clothes from coloured ones.
- ▶ Bed linen and pillowcases should be buttoned, so that small parts cannot stuck inside.
- ▶ Close zippers and hooks, and tie loose belts without metal parts, apron strings etc. together.
- ▶ Remove loose metal parts of clothes before putting into dryer such as metal buttons.
- ▶ Do not over-dry easy-care linen. Risk of creases. Allow final drying in open air.
- ▶ Clothes like knitwear can be over-drying sometimes. "Ironing" dry level are always recommended to choose.
- ▶ For pre-dried, multi-layered garments or for final drying , the Time Dry cycle should be selected.

### 6.3 Load clothes into the appliance

- ▶ Loosen up and insert presorted laundry.
- ▶ Don't overload.
- ▶ Close the door carefully. Make sure that clothes are not pinched.

### 6.4 Take out and add clothes

To remove or add clothes, the cycle can be interrupted at any time:

- ▶ The cycle will be interrupted if opening the door.  
Be careful when taking out or adding clothes! The Interior of the drum or the clothes themselves may be hot, so that there is danger of burns .
- ▶ To continue the cycle, first close the door, then press the Confirm button and the Start/Pause button.



## CAUTION!

Non-textile, as well as small, loose or sharp-edged items may cause malfunctions and damage of clothes and appliance.



## WARNING!

Never turn off the dryer before the end of the cycle, unless all items are removed and spread out quickly, so the heat can be released.



### 6.5 Loading the dryer

1. Place the laundry evenly in the drum making sure not to overload the dryer.
2. Switch on the tumble dryer by pressing the Power button (Fig.6-7).

## Notice

Fabric softeners or similar products should be used as specified in the manufacturer's instructions.

3. Set functions such as Temperature, Dry level, Delay, and then press the Confirm button and Start/Pause button (Fig. 6-8) to start the cycle.

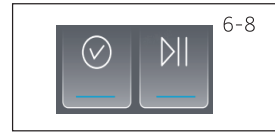

## 6.6 End of dry cycle

The tumble dryer stops operation automatically when a dry cycle is complete. The display shows END for about 5 seconds. Open the tumble dryer door and take out clothes .

1. Switch off the tumble dryer by pressing the Power button (Fig. 6-9).
2. Unplug the tumble dryer from the power socket (Fig. 6-10).
3. Empty the water tank after each dry cycle (Fig. 6-11).
4. Clean the lint filter after each dry cycle (Fig. 6-12).
5. Clean the condenser filter after each dry cycle (Fig. 6-13).

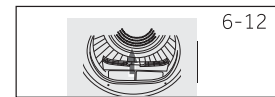
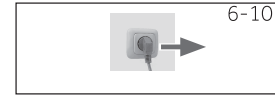
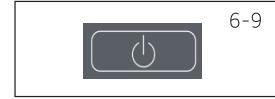

## 6.7 Use the Refresh

Connect the inlet pipe to the water valve (Fig.6-14). Turn on the tap and run Refresh cycle.

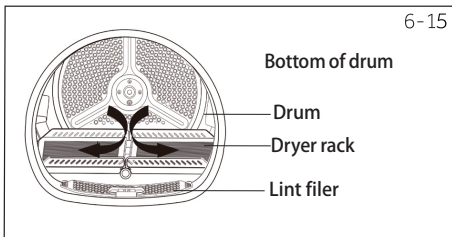
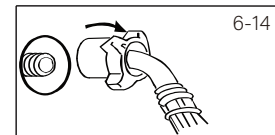

## 6.8 Use dryer rack

The dryer rack is designed for items which are not recommended for tumble drying such as trainers, sneakers, sweaters or delicate lingerie.

1. Open the dryer door.
2. Check that the drum is empty.
3. Put the dryer rack into the drum.

### **i** Notice

- ▶ Do not use this dryer rack when there are other clothes in the dryer.
- ▶ During drying, please make sure the items are placed on the rack with no risk of entangling the baffles while the drum is rotating.
- ▶ Maximum weight of wet items: 1.5 kg.

## 7.1 Lint filter cleaning

Clean the lint filter after each dry cycle.

1. Remove the lint filter from the drum (Fig. 7-1).
2. Open up the lint filter (Fig. 7-2).
3. Remove the lint residuals from lint filter (Fig.7-3).
4. Reinstall the cleaned lint filter in the tumble dryer (Fig.7-4).

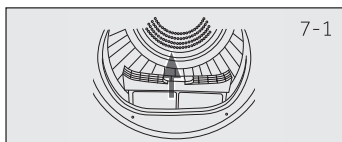

7-1



7-2

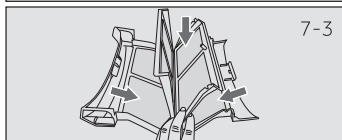

7-3

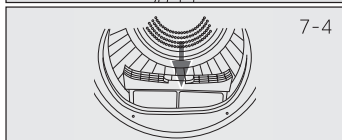

7-4

## 7.2 Condenser filter cleaning

Clean the filter after each dry cycle.

1. Open the door.
2. Pull out the lint filter from front duct (Fig.7-6).
3. Pull out the condenser filter from the air duct (Fig. 7-7).
4. Separate the sponge filter from the condenser filter and clean it from any residuals(Fig.7-8).
5. Reinstall the sponge to the condenser filter and put it back into the duct.

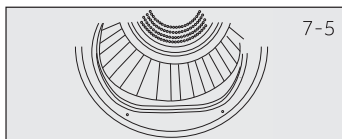

7-5

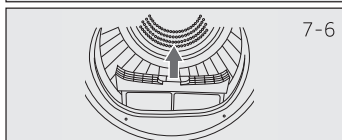

7-6

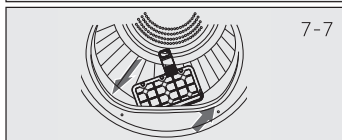

7-7

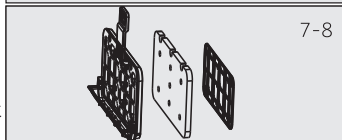

7-8



### Notice

If the lint / the condenser filter is very dirty, it can be cleaned under running water. Let it dry completely before use.

## 7.3 the inlet valve filter cleaning

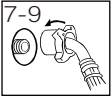

Screw the inlet pipe ( Fig. 7-9) .

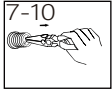

Remove the filter with needle-nose pliers (Fig. 7-10).



Clean the filter with a soft brush (Fig. 7-11).



Installing air filters (Fig. 7-12).



Connect the water inlet pipe again (Fig. 7-13).

7-14



## 7.4 Empty the water tank

During operation, steam is condensed into water and collected in the water tank. Empty the water tank after each drying cycle.

1. Pull out the water tank from its housing (Fig.7-14).

7-15



2. Empty the water tank (Fig. 7-15).

7-16



3. Reinstall the water tank to the tumble dryer (Fig. 7-16).



### Notice

Do not use the water for any kind of drinking or food processing.

## 7.5 Tumble dryer

Wipe the outside of the tumble dryer and the control panel with a damp cloth. Do not use any organic solvent or corrosive agent to avoid damage to the device.

## 7.6 Drum

After running for a while, micro elements like calcium and mineral substances contained in the water will result in an invisible film formed inside the drum. Use a damp cloth and some detergent to remove it. Do not use any organic solvent or corrosive agent to avoid damage to the device.

Many problems can be solved by yourself without specific expertise. please check all shown possibilities and follow below instructions before you contact an after sales service. See CUSTOMER SERVICE.



## WARNING!

- ▶ Before maintenance, turn off the appliance and disconnect the mains plug from the socket.
- ▶ Electrical equipment should be serviced only by qualified electrical experts, because improper repairs can cause considerable consequential damages.
- ▶ A damaged power cable should only be replaced by the manufacturer, its service agent or similarly qualified workers in order to avoid a hazard.

Display	Solution
Empty the tank icon is flashing.	Empty the tank.
F2:Clean the filter icon is flashing.	Contact the customer service.
F32:The temperature sensor located at the condenser outlet is broken.	Contact the customer service.
F33:The temperature sensor located at the compressor outlet it is broken.	Contact the customer service.
F4:Abnormal heating.	Contact the customer service.
FC2:The power board and the display board communication malfunction.	Contact the customer service.
FC0 :Main line malfunction.	Contact the customer service.
FC1:The motor communication malfunction.	Contact the customer service.
F7:The motor malfunction ( the motor driver board overload or overheating)	Contact the customer service.
FC6:The variable frequency fan communication malfunction.	Contact the customer service.
FE:The variable frequency fan operation malfunction.	Contact the customer service.
FH:IOT configuration failed.	Contact the customer service.
FCD:Communication failure of compressor drive board.	Contact the customer service.
FF:The compressor malfunction.	Contact the customer service.
FCU: The UI board and the display board communication malfunction.	Contact the customer service.

If the error codes appear again after taking measures, switch off the appliance, disconnect the power supply and contact the customer service.



## Troubleshooting without display-codes

Problem	Possible cause	Possible solution
Tumble dryer fails to operate.	<ul style="list-style-type: none"> <li>• Poor connection to the power supply.</li> <li>• Power failure.</li> <li>• No cycle selected.</li> <li>• Device has not been switched on.</li> <li>• The door is not closed properly.</li> </ul>	<ul style="list-style-type: none"> <li>• Check connection to the power supply.</li> <li>• Check the power supply.</li> <li>• Select a cycle.</li> <li>• Switch on the device.</li> <li>• Close the door properly.</li> </ul>
Tumble dryer fails to operate and the display shows END.	<ul style="list-style-type: none"> <li>• The laundry has reached the dry level defined by the program.</li> </ul>	<ul style="list-style-type: none"> <li>• Check the program setting is appropriate or not.</li> </ul>
Drying time is too long and the results are not satisfactory	<ul style="list-style-type: none"> <li>• The cycle setting is not correct.</li> <li>• The filter is clogged.</li> <li>• The evaporator is blocked.</li> <li>• The tumble dryer is overloaded.</li> <li>• The laundry is too wet.</li> <li>• The vent duct is blocked.</li> </ul>	<ul style="list-style-type: none"> <li>• Make sure the cycle is set correctly.</li> <li>• Clean the filter.</li> <li>• Clean the evaporator.</li> <li>• Reduce the amount of laundry.</li> <li>• Spin the laundry completely before drying.</li> <li>• Check and clean the vent duct.</li> </ul>
Remaining time-on the display-stops or skips.	<p>The remaining time will be adjusted continuously based upon the following factors:</p> <ul style="list-style-type: none"> <li>• Fabric of laundry.</li> <li>• Loading weight.</li> <li>• Moisture degree of the laundry.</li> <li>• Ambient temperature.</li> </ul>	<p>The automatic adjustment is a normal operation.</p>

## Product dimensions

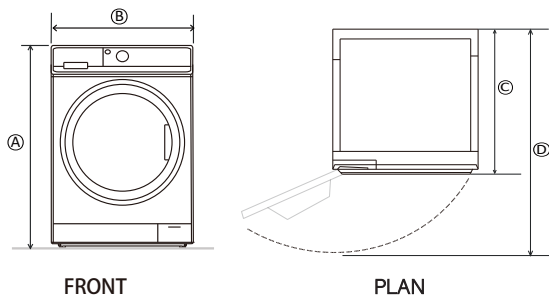

### PRODUCT DIMENSIONS

- (A) Overall height\*
  - Min : 845mm
  - Max : 850mm
- (B) Overall width : 595mm
- (C) Overall depth : 678mm\*\*
- (D) Depth of open door : 1169mm

\*Exact height is dependent on foot adjustment  
\*\*Including dial and door (when closed)

## Cavity dimensions

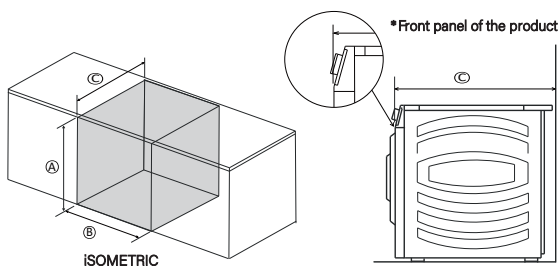

### CAVITY DIMENSIONS

- (A) Minimum cavity height : 860mm
- (B) Minimum cavity width : 622mm
- (C) Minimum cavity depth
  - Flush with front panel : 686mm\*
  - In cupboard : 748mm

## Clearance dimensions

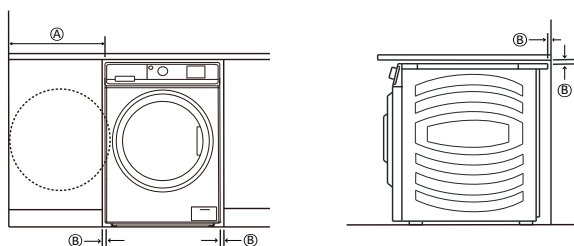

### CLEARANCE DIMENSIONS

- (A) Minimum dryer door clearance to adjacent wall : 240mm
- (B) Minimum gap clearance to \* adjacent product or cabinetry : 15mm

\*Applies to sides, top and rear

### Electrical

Volts(V): 220-240

Hz: 50

Power consumption(w) : 650

## 9.1 Preparation

Remove all packages including the polystyrene base firstly. While removing the package, water drops may be observed. This is normal phenomenon, a result from water test in the factory.



### Notice

Dispose of the package in an environmental friendly manner. For information regarding current disposal sites, consult your retailer or the local authorities.



### WARNING!

After transportation and installation, you must leave the dryer to stand for two hours before use.

## 9.2 Transport and waiting time

Transport the appliance in horizontal position only. The maintenance-free lubrication oil is located in the capsule of the compressor. This oil can get through the closed pipe system during slanting transport. Before connecting the appliance to the power supply you have to wait 2 hours so that the oil runs back into the capsule.

## 9.3 Place the appliance

The appliance should be placed on a flat and solid surface. Adjust the feet to the desired level (Fig. 9-1).

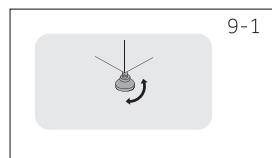

## 9.4 Electrical connection

Before each connection check if:

- ▶ Power supply, socket and fuse are appropriate to the rating plate.
- ▶ The power socket is earthed and no multi-plug or extension.
- ▶ The power plug and socket are fully matched.



### WARNING!

If the supply cord is damaged, it must be replaced by the service agent ( warranty card) in order to avoid a hazard!

## 9.5 Reversing the door

- ▶ Before you start, unplug the dryer from the socket.
- ▶ Handle parts carefully to avoid scratching paint.
- ▶ Provide a non-scratching work surface for the doors.
- ▶ Tools you will need: Phillips-head screwdriver.
- ▶ Once you begin, do not move the cabinet until door reversal is completed.
- ▶ These instructions are for changing the hinges from the right side to the left side. If you want to switch them back to the right side, follow these same instructions and reverse all references from left to right.

### 1.Remove the door assembly

Open the door. Remove the two screws holding the hinge / door assembly to the dryer. Carefully set the hinge/door assembly aside(Fig. 9-2).

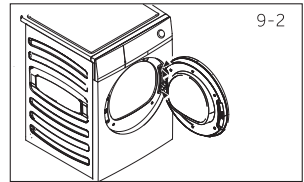

### 2. Remove, rotate and replace the inner door

Remove the eight stickers and screws securing the inner door to the outer door. Dismantle the inner door, rotate it 180° and reinstall it into the outer door using the same eight screws and stickers ( Fig. 9-3 ).

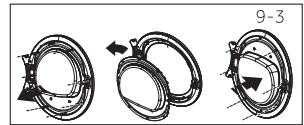

### 3.Remove, rotate and replace the door lock & strike plate

Remove the two screws holding the strike plate, and then remove one screw of the door lock, push down and take out the lock, rotate 180° and install it on the opposite side using the same 3 screws and strikes ( F ig. 9-4 ).

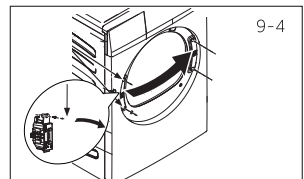

### 4.Rotate and replace the hinge/door assembly

Rotate the hinge/door assembly and screw it on the dryer (Fig. 9-5).

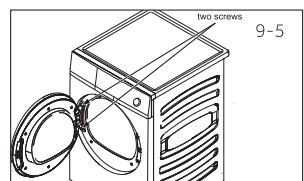

### 9.6 Stacking Installation(Fig.9-6)

For the stacking installation method, refer to the instructions of the Stacking Kit .

- ▶ A stacking kit **MUST BE USED** between the products and fitted correctly to the washing machine and dryer as per stacking kit instructions.
  - Ensure you use the compatible stacking kit for your washer and dryer combination.
  - Stacking kits are available through your Haier Brand dealer or online.
  - Ensure that the power plug is always accessible.
- ▶ The following stacking configurations are not safe and **MUST NOT** be used:
  - A washer stacking on top of a dryer.
  - A washer on top of a washer.
  - An incompatible washer/dryer/stacking kit combination.

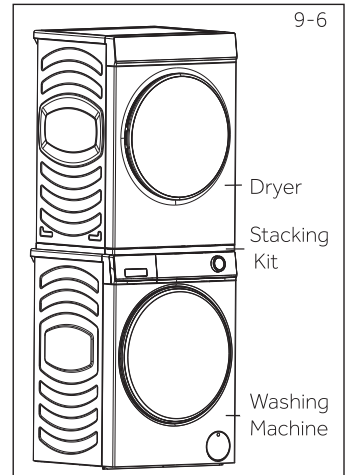

- ▶ The following washing machine models can be stacked with this machine using a Stacking Kit. For more information, please refer to the Installation Guide in the stacking kit package.
  - HDHP90NW1:HWF10NW1, with stacking kit ASKDNW1
  - HDHP90NB1:HWF10NB1, with stacking kit ASKDNB1

## 9.7 Level the dryer

It is IMPORTANT to level the dryer to ensure the machine runs efficiently with minimal noise. The dryer should be leveled, so it stands balanced with all four feet on the ground. Ensure the dryer does not rock in any direction.

### Level the dryer side to side(Fig.9-7)

- Place the gradienter at the centre back of the dryer.
- Adjust the rear feet until the dryer is level side to side.
- Never fully screw the feet completely from their housings.

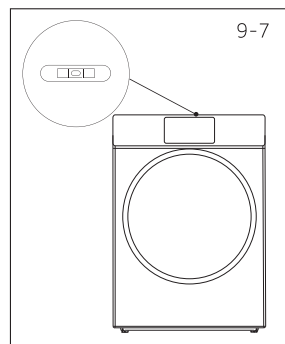

### Level the dryer front to back(Fig.9-8):

- Place the gradienter on the left side.
- Adjust the front left foot (wind down).
- Repeat the above steps for the right foot.

### Double check the dryer is balanced(Fig. 9-8):

- Place the gradienter at the centre front of the dryer.
- Ensure the dryer does not rock in any direction.
- If dryer is not balanced repeat the above steps.

After levelling, the corners of the dryer cabinet should be clear of the floor and the dryer must not rock in any direction.

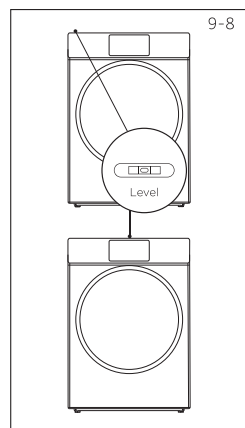

## 9.8 Draining

The dryer is equipped with a condenser unit which accumulates water during the drying cycle. This water is collected in the removable water tank located at the top left of the dryer. The accumulated water must be emptied after each drying cycle or you can setup your dryer to drain automatically using the drain hose included.

We recommend the dryer is set up to drain automatically where possible especially when drying full loads, this will avoid the risk of having to empty the water tank during a cycle.

### Connecting the drain hose

Remove the black hose from the connection at the back of the dryer (Fig. 9-9).

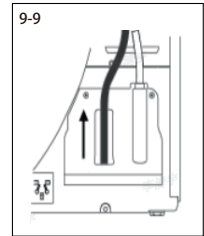

Uncoil the grey drain hose (included with your dryer) and connect it to the machine drain port (Fig. 9-10).

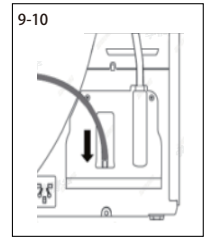

Place the other end of the drain hose into a tub or standpipe.

## **Customer Care**

We recommend our Haier Customer Service and the use of original spare parts.  
If you have a problem with your appliance, please first check the section TROUBLESHOOTING.

If you cannot find a solution there please contact:

- Your local dealer, or
- The Service and Support area at [www.haier.com](http://www.haier.com) where you can find telephone numbers, FAQs and where you can activate a service claim

Before contacting our service team, ensure that you have the following information available.  
The information can be found in the rating plate.

Model No. \_\_\_\_\_

Serial No. \_\_\_\_\_

Also check the Warranty Card supplied with the product in case of warranty.  
For general business enquiries and for more information, please refer to [www.haier.com](http://www.haier.com)









HDHP90NW1/HDHP90NB1

**Haier**