

FROST FREE VERTICAL FREEZER

Models : HVF220WH2
HVF220SS2
HVF260WH2
HVF260SS2
HVF300WH2
HVF300SS2
HVF260WH3
HVF260WH3-LH
HVF260SS3
HVF260SS3-LH
HVF300WH3

Installation Instructions and User Guide

ELEMENTS

Thanks for purchasing a Haier Product

Please read these instructions carefully before using this appliance. The instructions contain important information which will help you get the best out of the appliance and ensure safe and proper installation, use and maintenance.

Keep this manual in a convenient place so you can always refer to it for the safe and proper use of the appliance.

If you sell the appliance, give it away, or leave it behind when you move house, make sure you also pass on this manual so that the new owner can become familiar with the appliance and safety warnings.

WARNING: Risk of fire/flammable material. The symbol indicates there is a risk of fire since flammable materials are used. Take care to avoid causing a fire by igniting flammable material.



Manufacture: Qingdao Haier Special Icebox Co., Ltd.

Address : Haier Garden, Qianwangang Road, Economic
Development Zone, Qingdao 266555, Shandong, P.R.China

www.haier.com.au

www.haier.co.nz

INDEX

Safety Warnings.....	3
Before Use	6
Functions	8
Maintenance	15
Trouble-Shooting	16

SAFETY WARNINGS

Before use...

WARNING-This appliance designed for use with 220-240V AC power supply.

Please connect the appliance to normal voltage. In case of voltage fluctuation or power outage, the appliance may fail to start up, to avoid damage to the components of the freezer, disconnect the product from the power supply and wait 5 minutes before reconnecting.

WARNING-Do not damage the power cord.

Do not pull on the power cord to disconnect the plug. Please hold the plug to detach it directly from the socket.

The body of the appliance should not press on the power cord and do NOT stamp on the power cord.

WARNING-If the power cord is damaged, or the plug is worn, do not use. The worn or damaged power cord must be replaced by the manufacturer or by an authorised service person.

WARNING-Keep ventilation openings, in the appliance enclosure or in the built-in structure, clear of obstruction.

WARNING-The appliance is not intended for use by persons (including children) with reduced physical, sensory or mental capabilities, or lack of experience and knowledge, unless they have been given supervision or instruction concerning use of the appliance by a person responsible for their safety.

WARNING-Only take the required amount of food from the freezer. Defrosted food cannot be re-frozen, unless it is first cooked.

To freeze fast select the fast freezing function (see functions chapter) 2 hours before storing fresh food.

WARNING-Do not load excessive quantities of fresh food in the freezer. Please refer to the freezing capacity of the freezer.

WARNING-Do not touch the inside surface of the freezer storage compartment when in operation, especially with wet hands as your hands may freeze onto the surface.

WARNING-Open the door by the handle.

WARNING-Never store flammables, explosives or highly corrosive acids, alkalis and other chemicals in or around the freezer.

WARNING-Never store bottled beer or beverages in the freezer, as these will burst during freezing.

WARNING-Pay attention to your children

Children should be supervised to ensure that they should do not play with the appliance.

Do not hang on the door to avoid personal injury as the door or the appliance may be pulled over.

Make sure the hands or feet of the children do not enter holes and side seams of the metal parts such as the compartment or the back of the appliance to avoid personal injury.

Do not place unstable articles (heavy objects, containers filled with water) on the top of the appliance, to avoid personal injury caused by falling or electric shock caused by contact with water.

WARNING-Keep away from water

Do not use water to spray on or flush the refrigerator, and do not place the refrigerator where it may be splashed with water, to avoid impact to the electric insulation performance of the appliance or even electric shock or fire.

WARNING-Do not damage the refrigerant circuit as it contains flammable refrigerant.

Repair of the appliance must be performed by an authorised service person.

WARNING-Unplug the power plug

Before cleaning and maintenance, or in case of failure of appliance or power off, please unplug the power plug of the refrigerator. When unplugging the appliance allow at least 5 minutes before restarting, as frequent starting may damage the compressor.

WARNING-This freezer is a household appliance for storing food only. Do not store blood, medicines, biological products or other products in the appliance.

WARNING-Before any cleaning operation, make sure to disconnect the freezer from the power supply by pulling out the plug, it isn't enough to turn off the appliance pushing the power button.

SAFETY WARNINGS

WARNING-The freezer is very heavy. When you are moving it for cleaning or repair, take care not to damage the floor. Keep the freezer upright during moving. Do not move the freezer by rocking it to avoid damage to the floor.

WARNING-Do not spray or flush the freezer with water to avoid damage to the cabinet and electrical components.

WARNING-Do not clean with hard brush, wire brush or chemicals.

WARNING-When cleaning the display screen and other electrical components, use a dry cloth.

WARNING-To ensure the service life of the appliance, it is recommended that the freezer not be turned off unless it is necessary.

WARNING-never place the freezer horizontally on its side, front or back.

WARNING-This appliance contains a small quantity but flammable, non-synthetic R600a refrigerant.

WARNING-Upon opening and installing your product, check that the tubing of the refrigerant circuit is not damaged during transportation.

WARNING-Leaking refrigerant may cause eye injuries or ignite.

WARNING-Do not damage the refrigeration circuit.

WARNING-If you are unsure of the refrigerant type check the rating plate on the back of the unit.

It is hazardous for anyone other than an authorised service person to service this appliance.

In Queensland, the authorised service person must hold a Gas Work Licence or Authorisation for hydrocarbon refrigerants, to carry out servicing or repairs which involve the removal of covers.

WARNING-When positioning the appliance, ensure the supply cord is not trapped or damaged.

WARNING-Do not locate multiple portable socket-outlets or portable power supplies at the rear of the appliance.

WARNING-Disconnect power and empty the appliance before you start the operation.

WARNING-The lamps can only be replaced by the manufacturer, together with a part of the appliance.

WARNING-This appliance is intended to be used in household and similar applications such as,

Staff kitchen areas in shops, offices and other working environments,

Farm houses and by clients in hotels, motels and other residential type environments,

Bed and breakfast type environments,

Catering and similar non-retail applications.

WARNING-Do not use mechanical devices or other means to accelerate the defrosting process, other than those recommended by the manufacturer.

WARNING-Do not use electrical appliances inside the food storage compartments of the appliance, unless they are of the type recommended by the manufacturer.

Do not store explosive substances such as aerosol cans with a flammable propellant in this appliance.

Disposal



The presence of this symbol on the product, accessories or materials that goes with this information indicates that at the end of its useful life the product should not be disposed with other household waste. To prevent possible damage to the environment or human health from uncontrolled waste disposal, please separate these items from other types of waste and recycle them. This will promote the sustainable reuse of material resources.

Household users should contact either the retailer where they purchased the product or the relevant local authorities to find out how they can take this item for safe recycling and safe disposal.

Business users should contact their supplier and check the conditions of the purchase. This product should not be mixed with other commercial waste.

SAFETY WARNINGS







Freezing and storage of fresh food

Food shall be stored with a space in between, to allow cool air to circulate around food items.
Food shall be stored in different categories so that you can find it more easily.
Food shall be sealed before being stored in the freezer to avoid water loss and smells and tainting.
The outside of the packing must be dry to avoid bags sticking together. Packing materials should be odor-free, airtight, non poisonous and non-toxic.

We suggest to identify food information as follows:

- Name of food
- Weight of portion
- Quantity (number of pieces)
- Freezing date

See the diagram inside the freezer for common food storage time limits(in months):

PIZZA BOX		
 2-6	 4-8	 6-12
		

- 1、Casseroles,ice cream, sausages, bread
- 2、Fish, shrimp, lamb, meat cuts
- 3、Vegetables, fruits, poultry, beef

Food should be fresh, mature and of good quality.

Fresh vegetables and fruits must be frozen, if possible, immediately after harvest to maintain the most nutrients, structure, texture, color and taste.

In case of meat and game, it is preferable to hang for a sufficiently long period before freezing.

Hot food should be cooled down to room temperature prior to placing it in the freezer.

Energy Saving Tips

Install the appliance in a cool, dry room with adequate ventilation.

When installing the appliance, a space of at least 100mm must be kept above 20mm on each side and 50mm at the rear of the freezer to ensure adequate ventilation.

Allow warm food to cool down before placing it in the appliance.

Do not keep the door of the appliance open for too long when putting food in or taking food out. The shorter time, for which the door is open, the less ice will form in the freezer.

Clean the rear external condenser of the freezer regularly . Dust increases energy consumption.

Do not set temperature colder than necessary.

Do not cover or block air vent openings

BEFORE USE

Description

This diagram may differ slightly different from the layout of the freezer you have just purchased.

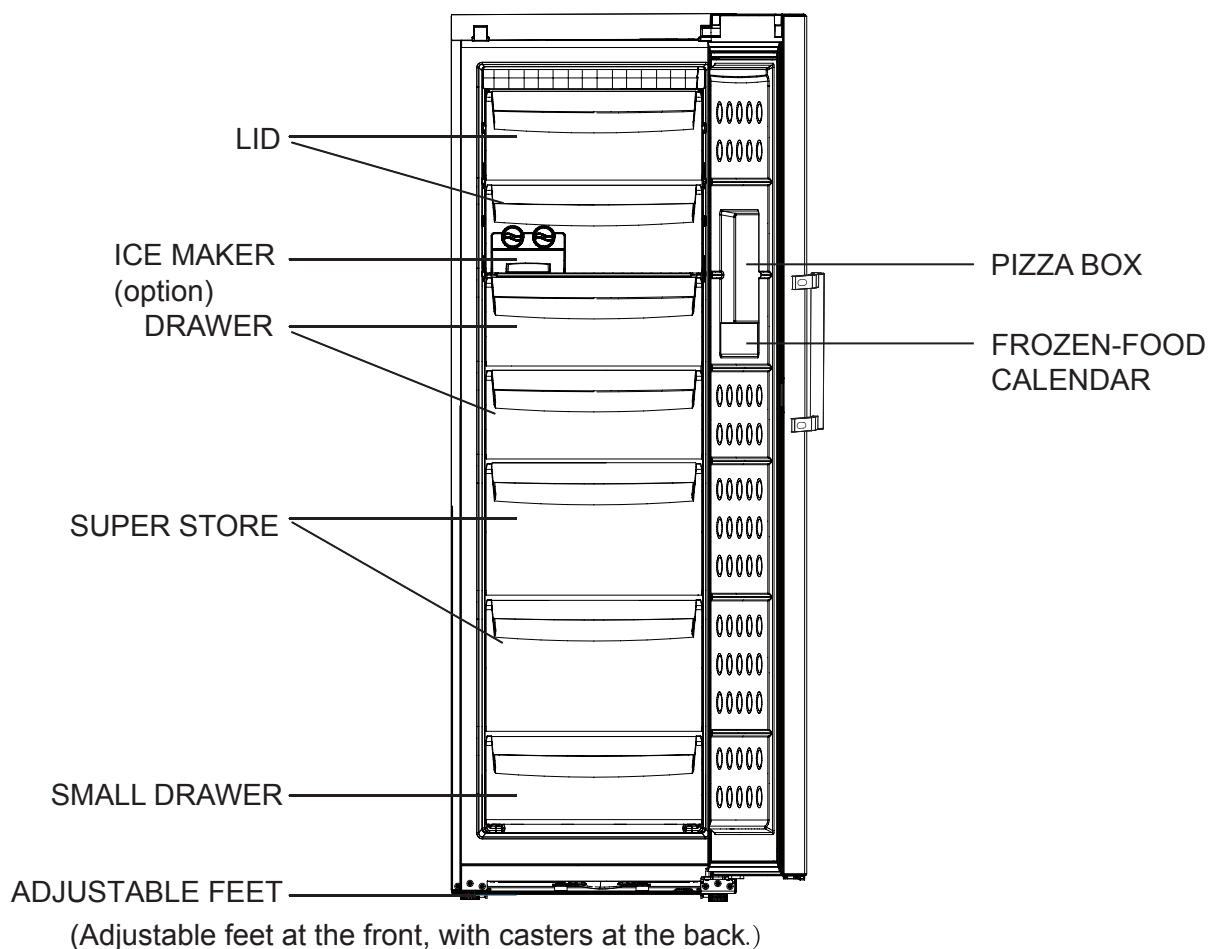

Drawers can be removed to increase freezer storage space.

BEFORE USE

Environment

The freezer should be placed on a flat and solid surface. If the appliance is placed on a pedestal, flat strong and fire resistant materials must be used. Never use the foam packing material as a pedestal. If the freezer is slightly unstable, you can adjust the adjustable feet of the freezer by turning them clockwise or counterclockwise to increase or decrease the height of the freezer. Do not place the freezer in direct sunlight or in a place where it is exposed to external heating source, this will ensure the optimum performance of the Freezer.

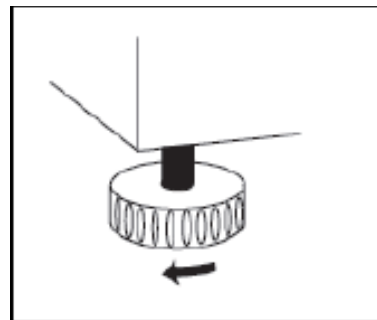

Install the appliance in a well ventilated place and a space of at least 100mm must be kept above the freezer 20mm space on each side, and 50mm behind the freezer.

Never place the freezer in a damp area or location where it may be splashed with water. Clean and dry any water splashes and stains with soft cloth immediately to prevent rust.

Do not place the freezer where the temperature is too low (under 5°C). Do not operate freezer outside.

Preparation prior to use

Remove all package parts, the foam base and the adhesive tape fixing accessories. Place the freezer in location (please refer to Placing Environment).

Clean the inside and outside of the freezer before use (please refer to Defrosting and Cleaning)

After the appliance has been leveled and cleaned, let it stand for 10-30 minutes before switching it on.

FUNCTIONS

Controls panel

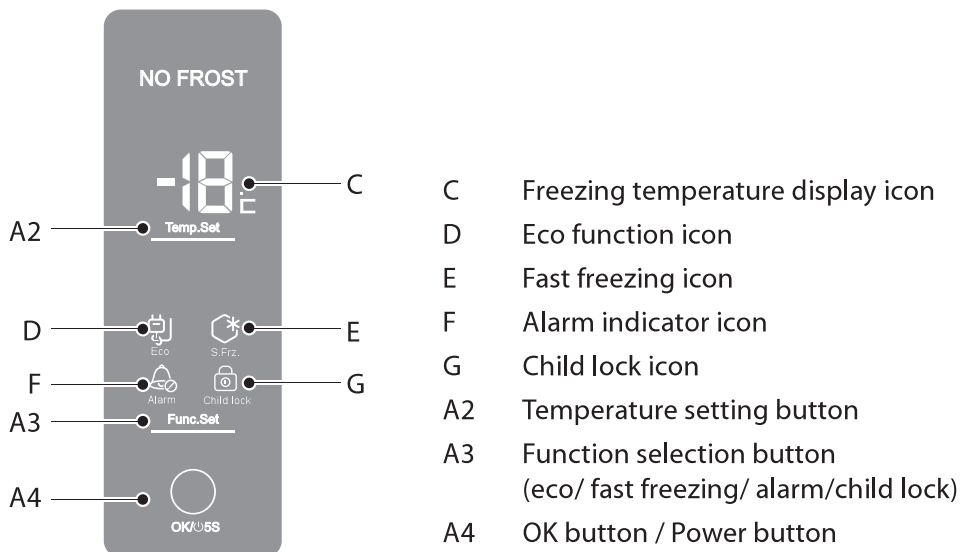

Start-up

Insert the plug into the wall socket and switch the power supply on. at this time the display (C) will show the actual temperature inside the freezer .

The alarm led F and acoustic signal will indicate that the temperature inside freezer is not sufficiently cold for storage of foodstuffs. Pressing the button A3 to choose the "Alarm" function then press the button A4, you can disable acoustic signal, but warning light will be on till freezer will reach the temperature of 0°C. When display show the temperature of 0°C, alarm condition will stop automatically and freezer will be ready for food storage.

Check the Controls Panel:

Touch any button on the display screen and check whether the temperature area and the selected icon can illuminate.

Set temperature:

To set temperature, push the button A2. During temperature setting two numbers on display show the point set in flashing mode. Press the A2 button again to scroll through the settings, the product can be set from -14°C to -26°C .

If no action is done on the OK button within 5 sec, the set point will be stored automatically.

After the temperature is set, the display will revert to showing the actual temperature.

Manufacturer setting of temperature is -18°C .

Power function:

Press the button A4 for 5 sec to turn off the freezer, press again for 5 sec to turn the freezer back on.

FUNCTIONS

Freezer functions

FAST FREEZING: Press the button A3 to choose the "S.FRZ" function, then press the button A4, this activates the fast freezing function.

The fast freezing icon, E, will be illuminated to indicate the function is on.

The light will be on until the FAST FREEZING function is switched off.

If you have a large amount of food to freeze at one time, it is recommended that the function be activated 30 hours before inserting food. The function will stop automatically after 56 hours or if manually switched off. Power consumption will increase when this function is on.

FUNCTION ECO: When the screen is unlocked, press the button A3 to choose the "ECO" function, then press the button A4, this will activate the ECO function to save energy. The freezer will maintain a temperature of -18°C to -14°C. If the temperature has been set at -19°C or lower, it will be set automatically at -18°C when the ECO function is on.

If this function is activated, led D will be on until the ECO function is switched off manually.

You can press the button A3 to choose the "ECO" function, then press the button A4 to disable the function. ECO function and Fast Freezing function can not be used simultaneously.

General Operation: When the temperature is set within a range from -23°C to -26°C, and after the freezer has run for 56 hours, it will automatically revert to -22°C, in order to save energy and to effectively preserve food. Ordinary food can be effectively preserved at -18°C or below, setting the temperature too low increases electricity consumption. (This function does not need to be manually activated)

Child Lock: When the screen is unlocked, press the button A3 to select the Child Lock function and then press the button A4, the function will be on. **Unlock:** Touch any button on the screen, the display screen and the child lock button will be illuminated; press the button A3, the child lock button flickers; press the button A4, the screen will be unlock.

When the screen is locked, the button A2 is not effective; just the Child Lock function icon is enabled when the A3 button is pressed, then the A4 button power function is disabled.

Alarm signals

TEMPERATURE ALARM: if temperature inside freezer is above 0°C, an intermittent buzzer and the flashing led F will indicate the temperature alarm. Display will show you code HH

After the screen is unlocked, press the button A3 to choose the "Alarm" function, then press the button A4, it's possible to stop acoustic sign, but alarm condition will continue until the internal temperature is colder than 0°C.

DOOR ALARM: If the door is left open for 60 seconds, the condition will be notified by intermittent buzzer. The alarm condition will stop by closing the door or by pressing button to select Alarm function and pressing the OK button, but in this second case alarm condition will restart after 120 seconds if door is still open.

At this time please check as per the following procedures: (1) Whether the door closes and opens well; (2) Whether the door is frequently opened, or it is opened for too long at a time; (3) Too much food is put in at one time; if the above conditions exist you can cancel the alarm. Until the temperature inside the freezer drops to 0°C or below, the displayed "HH" will continue to be displayed.

FUNCTIONS

Installation

Install the product with 100mm clearance above the product, 20mm each side, and 50mm clearance behind the product. This will ensure the product has adequate ventilation and will operate efficiently. Do not place on the product on flooring covered with carpet, overly flexible, unstable or easily damaged by moisture.

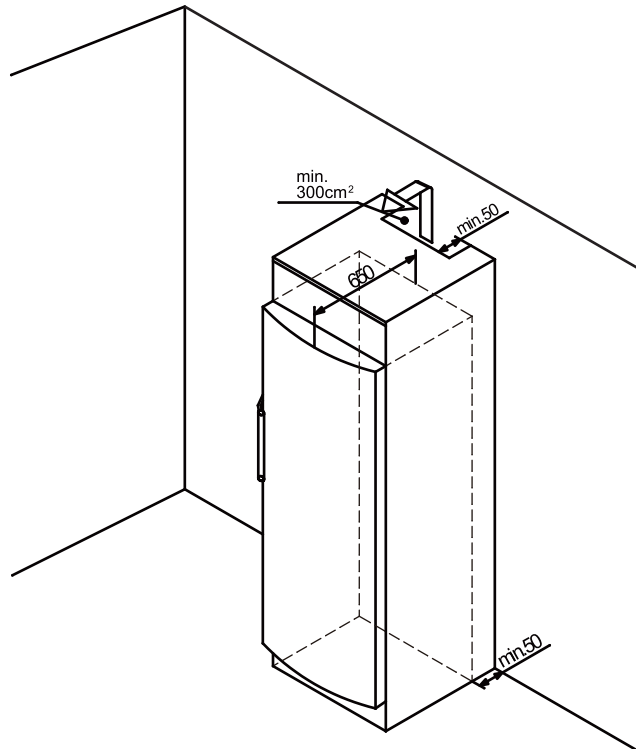

Use information

1. Upper shelf Doors

To open upper shelf doors, lift them slightly and turn inside out. Open the shelf door to put the food into the shelf. Ensure the shelf door is in the closed position before shutting the freezer door to avoid damage.

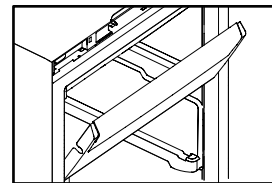

2. REMOVING DRAWERS

Pull the drawers out fully, then lift them up slightly in order to remove.

3. SUPER STORE DRAWER

Pull super store drawer out fully. Lift and pull it out of telescopic slides.

NOTE: Some models of the large drawer are set with slide structure. To remove the drawer lift up the rear slightly and slide the drawer out.

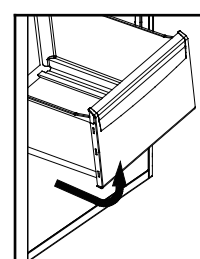
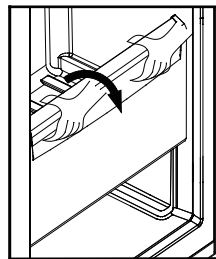
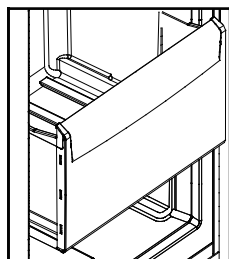

4. ICE CUBES PRODUCTION

Some models are equipped with manual ice system including ice cube trays with removal device and ice bin.

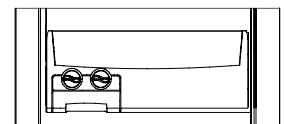

5. Remove ice trays

Clean and fill with water, Refit ice trays on its support.

Wait for a few hours for the ice to be frozen, then turn the knobs to extract the ice cubes.

The ice cubes will fall directly into the ice container.

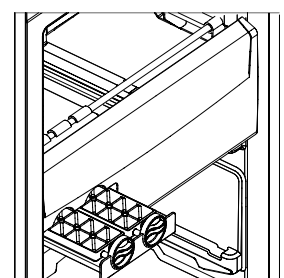

6. There is a storage compartment in the door of the freezer marked 'PIZZA', This is designed to hold a pizza or other similar sized item.

MAINTENANCE

Defrosting and cleaning

DEFROSTING THE FREEZER: The freezer defrosts automatically. No manual operation is needed.

CLEANING: The appliance should be cleaned regularly to prevent food odours.

Unplug the power cord before cleaning the freezer.

Clean the freezer with a soft cloth or sponge with warm water and mild detergent.

Dry water droplets on the refrigerator surface with a dry cloth.

Always keep the door gasket clean.

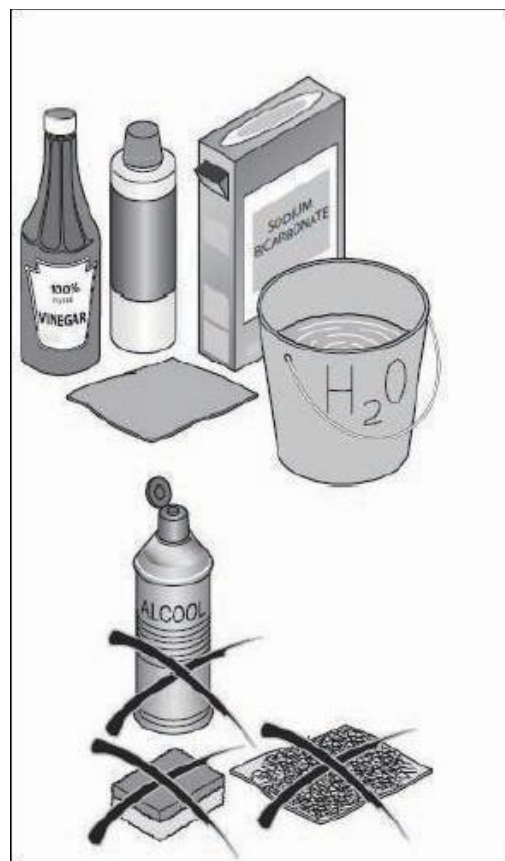

Stopping use

If the freezer will not be used for an extended period, please unplug the power cord and clean it with the method described above.

Keep the freezer door open when not in use to prevent any mold from forming in the compartment and producing bad odors.

Moving the freezer

Turn off the power and unplug the freezer.

Remove all food in the freezer.

Secure the drawers and other movable parts in the freezer with adhesive tape.

Close the door and secure with adhesive tape so that it will not open when moving.

Do not tilt the freezer more than 45 degrees (angle to vertical) to avoid damaging the refrigerating system when moving the freezer.

TROUBLE-SHOOTING

Before calling for service, please read the following troubleshooting table first. This can save both your time and money. The table contains common problems except those caused by defects in workmanship or material of the freezer.

PROBLEMS	CAUSES	SOLUTIONS
Freezer operation		
The compressor does not work	<ul style="list-style-type: none"> Product is in defrosting cycle. Freezer is not plugged into a power outlet. Product is turned OFF. 	<ul style="list-style-type: none"> <input type="checkbox"/> This is normal for an automatic defrosting freezer. <input type="checkbox"/> Check whether the plug, socket or fuse is damaged. Turn on the power when they are OK. <input type="checkbox"/> Press the power button or turn the dial to start up the freezer again.
The freezer runs frequently or runs for too long period	<ul style="list-style-type: none"> The indoor or outdoor temperature is high. <input type="checkbox"/> The freezer has been powered off for a period of time. <input type="checkbox"/> The door is open too frequently or for a long period at one time. <input type="checkbox"/> The door of the freezer is not fully closed. <input type="checkbox"/> The temperature setting is too low. <input type="checkbox"/> The door gasket is dirty, worn, cracked or mismatched. <input type="checkbox"/> The condenser is dirty. 	<ul style="list-style-type: none"> <input type="checkbox"/> In this case, it is normal for freezer to run longer. <input type="checkbox"/> Normally, it takes 6 to 12 hours for freezer to totally cool down. <input type="checkbox"/> Warm air enters the freezer and causes it to start frequently. Please do not open the door too frequently. <input type="checkbox"/> Ensure the freezer is located on a level ground and there is no food or container jarring the door. <input type="checkbox"/> Set the temperature higher until a satisfactory freezer temperature is obtained. It takes 24 hours for freezer temperature. <input type="checkbox"/> Clean or replace the door gasket. A leakage gap of door gasket can cause a longer running time of freezer in order to maintain desired temperature. <input type="checkbox"/> Clean the condenser on the rear of the product
Warm temperature		
Warm temperature inside product	<ul style="list-style-type: none"> The door is opened too frequently or for too long each time. <input type="checkbox"/> Temperature is set too warm. <input type="checkbox"/> The door is not closed fully. <input type="checkbox"/> Condenser is dirty. 	<ul style="list-style-type: none"> Warm air will enter the refrigerator whenever the door is opened. Try to open the door as less frequently as possible. <input type="checkbox"/> Reset the temperature. <input type="checkbox"/> Ensure the freezer is located on level ground and that there is no food or container preventing the door from closing fully. <input type="checkbox"/> Clean the condenser on the rear of the product.
Water / moisture / frost on outside surface of the freezer		
Moisture accumulates on the freezer's outside surface	<ul style="list-style-type: none"> Damp climate. <input type="checkbox"/> The door is not closed tightly. This causes condensation of cold air in the freezer and the warm air outside it. 	<ul style="list-style-type: none"> This is normal in damp climate. The moisture will decrease when the humidity drops.(this can be seasonal) <input type="checkbox"/> Make sure the ground is flat and no food or containers reach out of the door; close the door tightly.

TROUBLE-SHOOTING

PROBLEMS	CAUSES	SOLUTIONS
Bad odors in the freezer		
The inside of the freezer is dirty	The inside of the refrigerator needs cleaning. □ Food of strong odor is stored in the freezer.	Clean the internal of the freezer . (Please refer to Defrosting and Cleaning)
If you hear		
Beeps	The freezer door is open. □ The temperature in the freezer is too high. □ Some parts may be damaged.	Close the door or silence the alarm manually. □ The alarm is normal when it is first started or the food is stored for the first time. You can silence the alarm manually. □ Contact the authorised service person.
Abnormal sound	The freezer is not located on a level place. □ The freezer touches some object around it.	Adjust the feet to level the refrigerator. □ Remove objects around it.
Slight sound similar to that of flowing water	This is the sound of the refrigerating system.	Normal.
Heating of cabinet	The refrigerating system is working refrigerating system.	This prevents condensation and is normal.

Nameplate

The nameplate is located inside the freezer compartment located low down on the left side. The nameplate provides important information about the appliance and must not be tampered with or removed.

Valid capacity and rated power consumption shown on the nameplate is subject to relevant standards.