

Haier

Customer Service

We recommend our Haier Customer Service and the use of original spare parts.

If you have a problem with your appliance, please first check section TROUBLESHOOTING.

If you cannot find a solution there, please contact

- ▶ your local dealer or
- ▶ the Service & Support area at www.haier.com.au
or at www.haier.co.nz

where you can activate the service claim and also find FAQs.

To contact our Service, ensure that you have the following data available.
The information can be found on the rating plate at the door.

Model _____

Serial No. _____

User Manual Free Standing Cooker

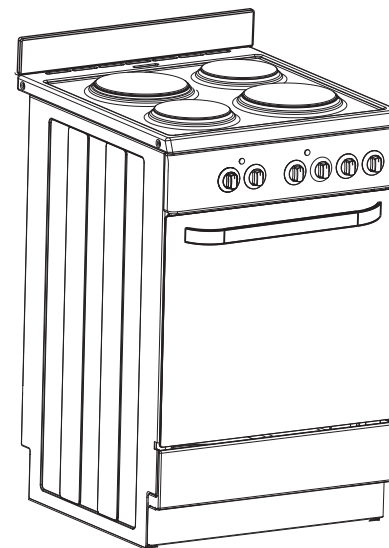

HOR54S5CW1

DEAR CUSTOMER

The cooker is exceptionally easy to use and extremely efficient. After reading the instruction manual, operating the cooker will be easy.

Before being packaged and leaving the manufacturer, the cooker was thoroughly checked with regard to safety and functionality.

Before using the appliance, please read the instruction manual carefully.

By following these instructions carefully you will be able to avoid any problems in using the appliance.

It is important to keep the instruction manual and store it in a safe place so that it can be consulted at any time.

It is necessary to follow the instructions in the manual carefully in order to avoid possible accidents.

Caution!

Do not use the cooker until you have read this instruction manual.

The cooker is intended for household use only.

The manufacturer reserves the right to introduce changes which do not affect the operation of the appliance.

TABLE OF CONTENTS

Safety instructions	3
How to save energy	4
Unpacking.....	5
Disposal of the appliance.....	5
Description of the appliance.....	6
Installation	7
Operation	9
Before first use.....	9
How to use the heating plate	9
Oven functions and operation	10
Cleaning and maintenance.....	12
Operation in case of emergency.....	14
Baking in the oven.....	15
Technical information.....	21
Electrical connection	22

SAFETY INSTRUCTIONS

- The appliance becomes hot during operation. Take care not to touch the hot parts inside the oven.
- Always keep children away from the cooker. While in operation direct contact with the cooker may cause burns!
- Ensure that small items of household equipment, including connection leads, do not touch the hot oven or the hob as the insulation material of this equipment is usually not resistant to high temperatures.
- Do not leave the cooker unattended when frying. Oils and fats may catch fire due to overheating.
- Do not allow the cooktop to get soiled and prevent liquids from boiling over onto the surface of the cooktop, Any spillages should be cleaned up as they happen.
- Do not place pans with a wet bottom on the warmed up heating zones as this can cause irreversible changes to the cooktop(irremovable stains).
- Do not switch on the cooktop until a pan has been placed on it.
- Do not put pans weighing over 15kg on the opened door of the oven and pans over 25kg on the cooktop.
- Do not use harsh cleaning agents or sharp metal objects to clean the doors as they can scratch the surface, which could then result in the glass cracking.
- Do not use the cooker in the event of a technical fault. Any faults must be fixed by an appropriately qualified and authorized person.
- In the event of any incident caused by a technical fault, disconnect the power and report the fault to the service centre to be repaired.
- The rules and provisions contained in this instruction manual should be strictly observed. Do not allow anybody who is not familiar with the contents of this instruction manual to operate the cooker.
- The cooker should not be cleaned using steam equipment.
- **WARNING:** Accessible parts may become hot during use. Young children should be kept away.
- **WARNING:** In order to prevent accidental tipping of the appliance ,for example by a child climbing onto the open door,the stabilizing means must be installed.
- The oven must be switch off before removing the guard and that,after cleaning,the guard must be replaced in accordance with the instrctions.
- Ensure that the appliance is switch off before replacing the lamp to avoid the possibility of electric shock.
- **WARNING:** Accessible parts will become hot when the grill is in use .Children shoule be kept away.
- The appliance is not intended to be operated by means of an external timer or separate remote-control system.
- This appliance is not intended for use by persons (including children) with reduced physical, sensory or mental capabilities, or lack of experience and knowledge,unless they have been given supervision or instruction concerning use of the appliance by a person responsible for their safety.
- Children should be supervised to ensure that they do not play with the appliance.
- If the supply cord is damaged, it must be replaced by the manufacturer or its service agent or a similarly qualified person in order to avoid a hazard.

If the appliance used in New Zealand,this cooking range must be connected to the supply by a supply cord fitted with an appropriately rated plug that is compatible with the socket-outlet fitted to the final sub-circuit in the fixed wiring that is intended to supply this cooking range.

HOW TO SAVE ENERGY



Using energy in a responsible way not only saves money but also helps the environment. So let's save energy ! And this is how you can do it:

- Use proper pans for cooking. Pans with thick, flat bases can save up to 1/3 on electric energy. Remember to cover pans if possible otherwise you will use four times as much energy!
- Match the size of the saucepan to the surface of the heating plates. A saucepan should never be smaller than a heating plate.
- Ensure heating plates and pan bases are clean. Soils can prevent heat transfer-and repeatedly burnt-on spillages can often only be removed by products which cause damage to the environment.
- Do not uncover the pan too often(a watched pot never boils!). Do not open the oven door unnecessarily often.
- Switch off the oven in good time and make use of residual heat.

For long cooking times,switch off heating zones 5 to 10 minutes before finishing cooking.This saves up to 20% on energy.

- Only use the oven when cooking larger dishes. Meat of up to 1 kg can be prepared more economically in a pan on the cooker burner.
- Make use of residual heat from the oven.

If the cooking time is greater than 40minutes it is recommended to switch off the oven 10 minutes before the end time.

Caution!

When using the timer set appropriately shorter cooking times according to the dish being prepared.

- Only grill with the ultrafan after closing the oven door.
- Make sure the oven door is properly closed. Heat can leak through spillages on the door seals.Clean up any spillages immediately.
- Do not install the cooker in the direct vicinity of refrigerators/freezers. Otherwise energy consumption increases unnecessarily.

UNPACKING



During transportation, protective packaging was used to protect the appliance against any damage.

After unpacking, please dispose of all elements of packaging in a way that will not cause damage to the environment. All materials used for packaging the appliance are environmentally friendly; they are 100% recyclable and are marked with the appropriate symbol.

Caution!

During unpacking, the packaging materials (polythene bags, polystyrene pieces, etc.) should be kept out of reach of children.

DISPOSAL OF THE APPLIANCE



Old appliances should not simply be disposed of with normal household waste, but should be delivered to a collection and recycling centre for electric and electronic equipment.

A symbol shown on the product, the instruction manual or the packaging shows if it is suitable for recycling.

Materials used inside the appliance are recyclable and are labelled with information concerning this. By recycling materials or other parts from used devices you are making a significant contribution to the protection of our environment.

Information on appropriate disposal centers for used devices can be provided by your local authority.

DESCRIPTION OF THE APPLIANCE

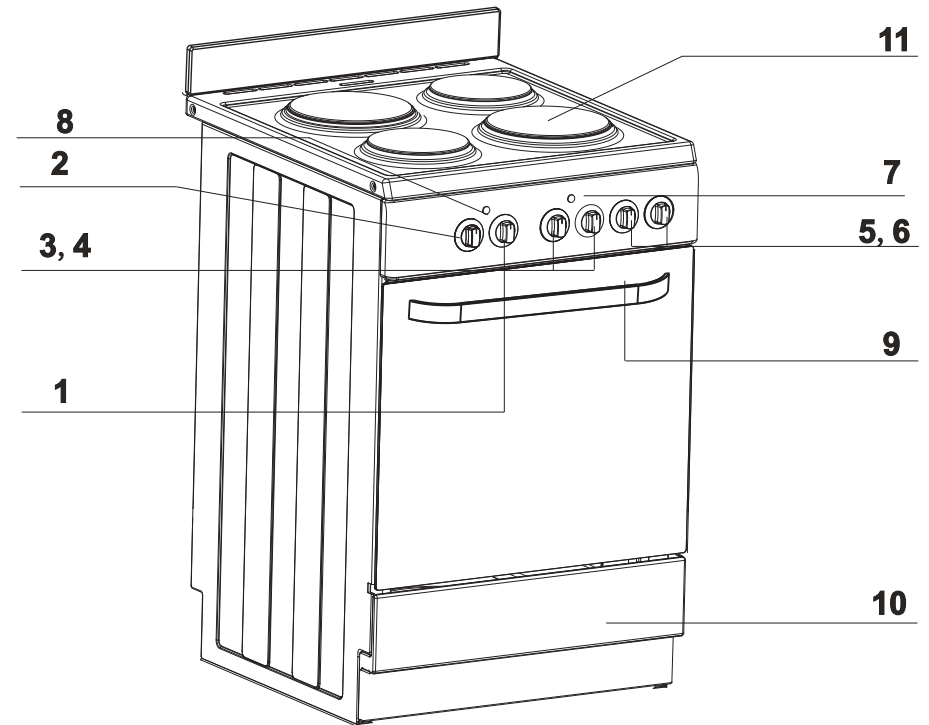

- 1 Temperature control knob
- 2 Oven function selection knob
- 3,4,5,6 Hotplate control knobs
- 7 Cooker operation signal light orange
- 8 Oven temperature signal light orange
- 9 Oven door handle
- 10 Drawer
- 11 Hotplate

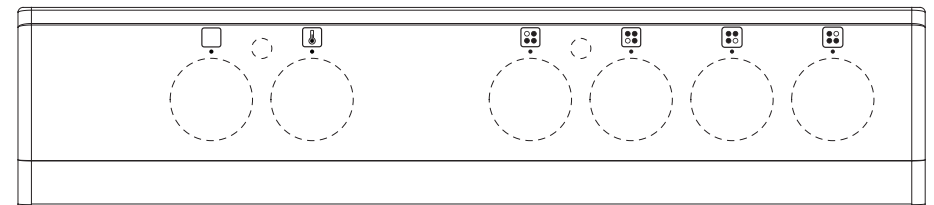

INSTALLATION

▶ Installing the cooker

- The kitchen should be dry and airy and have effective ventilation according to the existing technical provisions.
- The room should be equipped with a ventilation system that pipes away exhaust fumes created during combustion. This system should consist of a ventilation grid or hood. Hoods should be installed according to the manufacturer's instructions. The cooker should be placed so as to ensure free access to control elements.
- Coating or veneer used on fitted furniture must be applied with a heat resistant adhesive (100°C). This prevents surface deformation or detachment of the coating. If you are unsure of your furniture's heat resistance, you should leave approximately 2 cm of free space around the cooker. The wall behind the cooker should be resistant to high temperatures. During operation, its back side can warm up to around 50°C above the ambient temperature.
- The cooker should stand on a hard, even floor (do not put it on a base.)
- Before you start using the cooker it should be leveled, which is particularly important for fat distribution in a frying pan. To this purpose, adjustable feet are accessible after removal of the drawer. The adjustment range is +/-5mm.

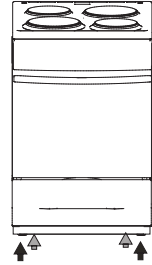

- Take the cover and cooker out of the packaging. Select a proper place, and steadily level the cooker.

Fix the cooker to the back wall with 2 chains

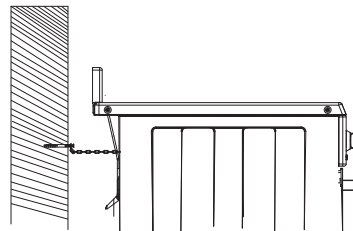

INSTALLATION

To fit the rear panel/splashback, slide the lugs on the bottom of the panel into the matching slots on rear of stove and fix with screws provided.

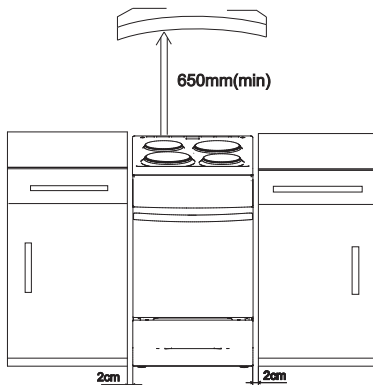
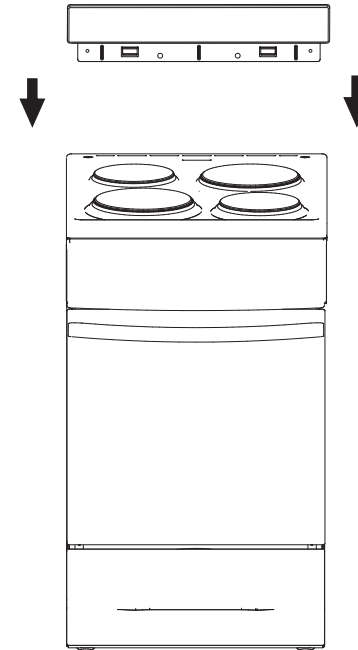

OPERATION

▷ Before first use

- Remove packaging and empty the drawer. Clean the interior of the oven with warm soapy water and wipe clean with moistened cloth or sponge. Wipe clean the cooktop.
- Take out and wash the oven fittings with warm water and a little washingup liquid.
- Switch on the ventilation in the room or open a window.
- Heat the oven (to a temperature of 250, for approx. 30 min.), remove any stains and wash carefully. The hotplates should be heated for around 4 minutes without a pan or pot on them.
- When heating the oven for the first time it is normal for the stove to give off smoke and manufacturing odours. These will disappear after about 30 Minutes.

▷ Using the hotplates

The level of heat can be adjusted gradually by turning the appropriate knob to the right or left.

Switching on the plate results in a red signal light on the control panel turning on.

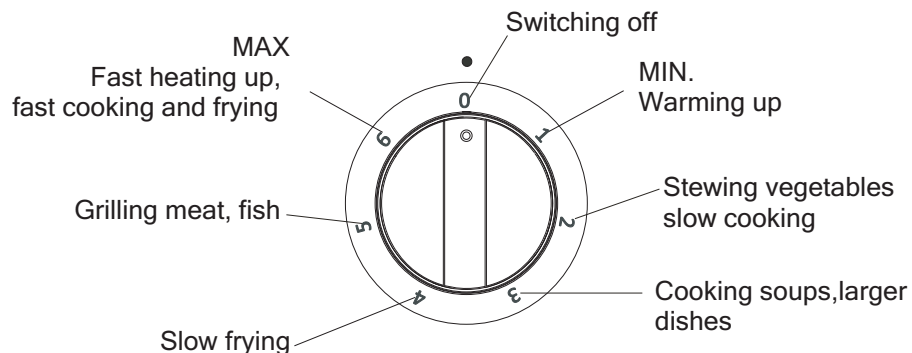

An appropriately selected pan saves energy.

A pan should have a thick, flat base with a diameter equal to the plate diameter, as in that case heat is transferred most efficiently.

Use

Do not use pots and pans that are unsteady and likely to rock or overbalance.

Do not operate the cooktop for an extended time without utensil on the hotplate.

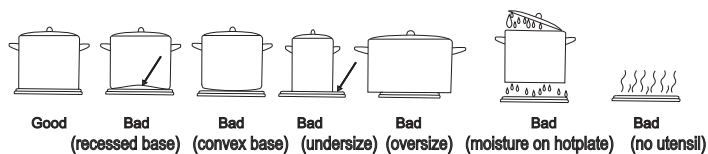

Caution!

Ensure the plate is clean - a soiled zone does not transfer all of the heat.

Protect the plate against corrosion.

Switch off the plate before a pan is removed.

Do not leave pans with prepared dishes based on fats and oils unattended on the switched - on plate; hot fat can spontaneously catch fire.

OPERATION

▷ Oven functions and operation

The oven is controlled by the function knob, timer knob and the temperature selection knob.

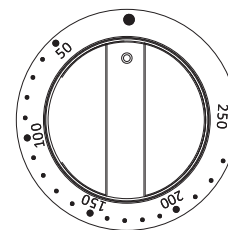

Temperature selection knob

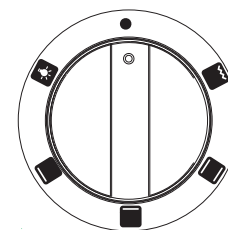

5 Function knob

Possible settings of the oven function knob

Caution!

At this oven function knob position. The oven is not being warmed up.

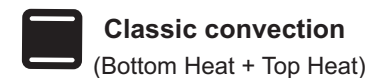

Setting the knob to this position allows the oven to be heated conventionally.



By setting the knob to this position the lighting inside the oven is switched on



At this oven function knob position, the oven activates the bottom heater.



At this oven function knob position, the oven activates the top element.

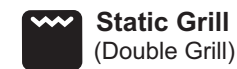

When the "combined grill" is active it enables grilling with the grill and with the top heater switched on at the same time.

This function allows a higher temperature at the top of the cooking area, which causes more intense browning of the dish and permits larger portions to be grilled.

OPERATION

Use of the grill

In order to switch on the grill you need to:

- Set the oven knob to the position marked grill.
- Heat the oven for approx. 5 minutes (with the oven door shut).
- Insert a tray with a dish onto the appropriate cooking level; and if you are grilling on the grate insert a tray for dripping on the level immediately below (under the grate).
- Close the oven door.

For grilling with the function grill and combined grill the temperature must be set to 250°C.

Warning!

When using grill function it is recommended that the oven door is closed.

When the grill is in use accessible parts can become hot.

It is best to keep children away from the oven.

Oven guide levels

Baking pans and accessories (oven grid, baking tray, etc) may be inserted into the oven in 5 guiding levels. Appropriate levels are indicated in the tables that follow.

Always count levels from the bottom upwards!

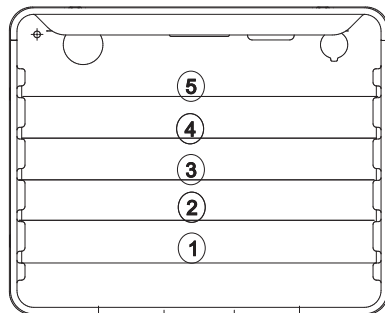

CLEANING AND MAINTENANCE

By ensuring proper cleaning and maintenance of your oven you can have a significant influence on the continuing faultfree operation of your appliance.

Before you start cleaning, the oven must be switched off and you should ensure that all knobs are set to the "0" position. Do not start cleaning until the oven has completely cooled.

▷ Oven

- The oven should be cleaned after every time use.
- Cool the oven completely before cleaning.
- Never clean the appliance with pressurized hot steam cleaner!
- The oven chamber should only be washed with warm water and a small amount of washing-up liquid.
- **Steam cleaning**

-pour 250ml of water (1 cup) into a bowl placed in the oven on the first level from the bottom.

-Close the oven door,

-Set the temperature knob to 50 °C, and the function knob to the bottom heater position,

-heat the oven chamber for approximately 30 minutes,

-Open the oven door, wipe the chamber inside with a cloth or sponge and wash using warm water with washing-up liquid.

- After cleaning the oven chamber wipe it dry.

Caution!

Do not use cleaning products containing abrasive materials for the cleaning and maintenance of the glass front panel.

● **Cleaning of Solid Hotplates**

- For light soiling and every day cleaning simply wipe with a moist cloth.
- For dirty hotplates use a commercial cleaner.
- Be careful to completely remove the cleaner and dry the hotplate by running the element for a short time.
- The hotplate can be then oiled with a thin coating of cooking oil or a suitable commercial product such as Hillmark Shineon.
- Some discolouration of the trim ring is normal during use.

CLEANING AND MAINTENANCE

▷ Changing the Oven Lamp

Before any maintenance is started involving electrical parts, the appliance must be disconnected from the power supply. If the oven has been in use, let the oven cavity and the heating elements cool down before attempting any maintenance.

Changing the bulb

- Unscrew the protective cover. We recommend that you wash and dry the glass cover at this point.
- Carefully remove the old bulb and insert the new bulb suitable for high temperatures (300°C) having the following specifications: 220-240V, 50Hz, 25W, G9 fitting.
- Refit the protective cover.

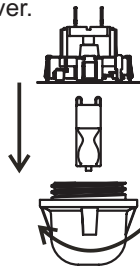

IMPORTANT

Never use screwdrivers or other utensils to remove the light cover. This could damage the enamel of the oven or the lampholder. Remove only by hand.

IMPORTANT

Never replace the bulb with bare hands as contamination from your fingers can cause premature failure. Always use a clean cloth or gloves.

Please note:

The bulb replacement is not covered by your guarantee

▷ Door removal

In order to obtain easier access to the oven chamber for cleaning, it is possible to remove the door.

To do this, tilt the safety catch part of the hinge upwards. Close the door lightly, lift and pull it out towards you. In order to fit the door back on to the cooker, do the reverse. When fitting, ensure that the notch of the hinge is correctly placed on the protrusion of the hinge holder. After the door is fitted to the oven, the safety catch should be carefully lowered down again. If the safety catch is not set it may cause damage to the hinge when closing the door.

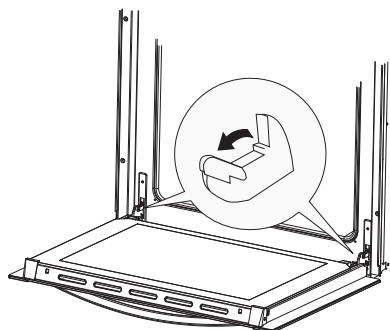

Tilting the hinge safety catches

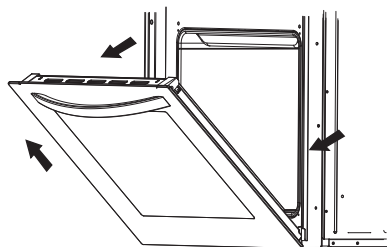

Door removal

CLEANING AND MAINTENANCE

▷ Removal of the internal glass panel

Unscrew and unfasten the plastic latch that is in the corner at the top of the door. Next take out the glass from the second blocking mechanism and remove. After cleaning, insert and block the glass panel, and screw in the blocking mechanism.

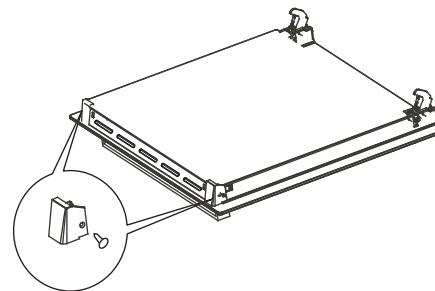

Removal of the internal glass panel

▷ Regular inspections

Besides keeping the cooker clean, you should:

- Carry out periodic inspections of the control elements and cooking units of the cooker. After the guarantee has expired you should have a technical inspection of the cooker carried out at a service centre at least once every two years.
- Fix any operational faults.
- Carry out periodical maintenance of the cooking units of the cooker.

Caution!

All repairs and regulatory activities should be carried out by the appropriate service centre or by an appropriately authorized fitter.

OPERATION IN CASE OF EMERGENCY

In the event of an emergency, you should:

- switch off all working units of the oven
- disconnect the mains plug
- call the service centre
- some minor faults can be fixed by referring to the instructions given in the table below. Before calling the customer support centre or the service centre check the following points that are presented in the table.

PROBLEM	REASON	ACTION
1. The appliance does not work.	Break in power supply.	Check the household fuse box; if there is a blown fuse replace it with a new one
2. The oven lighting does not work.	The bulb is loose or damaged.	Tighten up or replace the blown bulb (see Cleaning and Maintenance)

BAKING IN THE OVEN

▷ Baking cakes and loaves

Centre shelf position is most suitable for baking most cakes and loaves.

Warning!

- The baking parameters given in Tables are approximate and can be corrected based on your own experience and cooking preferences.
- In case you may not find any particular type of cake in the tables, use the information available for the next most similar type of cake.
- Whenever possible choose dark baking pans. Light ones reflect the heat and sometimes the cake will not be properly browned.
- Always place baking pans directly on wire shelves. For baking biscuits in the tray, remove the wire grid from the tray supplied.
- Preheating shortens the baking time. Do not put the cake in the oven until proper temperature is obtained.

Baking tips

Is the cake baked?

Pierce the cake with a fine skewer at the thickest part, if the dough does not stick to it, the cake is baked. You may switch off the oven and use the remaining heat.

Cake has fallen

Check the recipe. Use less fluid next time. Follow the mixing times, especially when using powered kitchen mixers.

Cake is too light on the bottom

Use dark baking pan next time, or place the pan one level lower, or switch on the lower heater a while before the completion.

Cheesecake is undercooked

Next time reduce the baking temperature and extend the baking time.

Warnings regarding the baking tables

- The tables indicate the temperature range. Always select lower temperature first. You may always increase the temperature in case pastry needs more baking.
- Baking times are indicative only. They may vary in dependence of individual characteristics.
- The asterisk indicates that the oven requires preheating.

BAKING IN THE OVEN

Pastry Baking Table

Type of pastry	Shelf Position (from down upwards)	Temp(°C) 	Baking time (in min.)
Sweet pastry			
Raisin cake	2	150-160	55-70
Ring cake	2	150-160	60-70
Tree cake (tart form)	2	150-160	45-60
Cheese cake (tart form)	3	160-170	60-80
Fruit cake	3	170-180	50-70
Fruit cake with icing	3	160-170	60-70
Sponge cake	2	160-170	30-40
Flake cake	3	170-180	25-35
Fruit cake mix dough	3	160-170	50-70
Cherry cake	3	170-200	30-50
Jelly roll	3	170-180	15-25
Fruit fan	3	150-160	25-35
Plait bun	3	180-210	35-50
Christmas cake	3	170-200	45-70
Apple pie	3	170-200	40-60
Puff paste	3	160-170	40-60
Salted pastry			
Bacon roll	3	170-180	45-60
Pizza	3	210-230	30-45
Bread	3	180-210	50-60
Rolls	3	200-220	30-40
Cookies			
Caraway roll	3	160-170	15-25
Biscuits	3	160-170	20-30
Danish pastry	3	170-200	20-35
Flaky pastry	3	180-200	20-30
Cream puff	3	170-200	25-45
Deep frozen pastry			
Apple pie, cheese pie	3	170-200	50-70
Cheese cake	3	170-180	65-85
Pizza	3	200-220	20-30
Chips for oven	3	200-220	20-35
Potato fries for	3	200-220	20-35

BAKING IN THE OVEN

▷ Roasting

Tips regarding roasting pans

- Cover your roast or wrap it in foil. It will preserve its juice and the oven will remain cleaner.
- If you leave the pan uncovered the roast will be cooked sooner. Roast large chunks of meat directly on the grid, with intercepting pan underneath.

Attention when roasting!

Roasting tables indicate suggested temperatures, guide guide and roasting times. Roast time largely depends upon the type of meat, its size and quality. So you may expect some variations.

- Roasting of large chunks of meat may produce excessive steaming and dew formation at the oven door. This is quite normal, and does not affect the operation of the oven. However, after the completion of roasting wipe the oven door and the glass thoroughly.
- Roasting of red meat, poultry and fish is rational if the roast exceeds one kilogram in size.
- Add as much liquid as necessary to prevent burning of juice, dripping from meat. Roast must be surveyed at all times. And liquid added if necessary.
- At approximately the middle of the indicated time turn the roast round, especially if you use the deep roast dish.
- When roasting on the grill grid, place the grid in the deep roasting pan and insert both into the sliding guide. The bottom pan will intercept dripping fat.

- Never leave roast to cool in the oven, as it might produce dew and corrosion of the oven.

BAKING IN THE OVEN

Roasting table

Type of meat	Weight (in kg)	Shelf position (from down upwards)	temp (°C)	Roasting time (in min.)
Beef				
Beef loin	1.0	2	200-220	100-120
Beef loin	1.5	2	200-220	120-150
Roast beef, rare	1.0	2	220-230	30-40
Roast beef, well done	1.0	2	220-230	40-50
Pork				
Pork roast with skin	1.5	2	170-180	140-160
Flank	1.5	2	180-190	120-150
Flank	2.0	2	170-200	150-180
Pork loin	1.5	2	200-220	120-140
Meat roll	1.5	2	200-220	120-140
Pork cutlet	1.5	2	170-200	100-120
Minced meat roast	1.5	2	210-220	60-70
Veal				
Veal roll	1.5	2	170-200	90-120
Veal knuckle	1.7	2	170-200	120-130
Lamp				
Lamp prime ribs	1.5	2	180-200	100-120
Mutton blade bone	1.5	2	180-200	120-130
Venison				
Hare ribs	1.5	2	180-210	100-120
Hare blade bone	1.5	2	180-210	100-120
Boar ham	1.5	2	180-210	100-120
Poultry				
Chicken entire	1.2	2	200-210	60-70
Hen	1.5	2	200-210	70-90
Duck	1.7	2	170-200	120-150
Goose	4.0	2	150-160	180-200
Turkey	5.0	2	140-150	180-240
Fish				
Fish, entire	1.0	2	200-210	50-60
Fish soufflé	1.5	2	170-200	50-70

BAKING IN THE OVEN

▷ Grilling

- Take extra precautions when grilling. Intensive heat from infrared heater makes the oven and the accessories extremely hot. Use protective gloves and barbecue accessories!
- Perforated roast may produce spurting of hot grease(sausages). Use long grill tongs to prevent skin burns and protect your eyes.
- Supervise the grill at all time. Excessive heat may quickly burn your roast and provoke fire!
- Do not let the children in the vicinity of the grill.

Grill heater is especially suitable for the preparation of low-fat sausages, meat and fish fillets and steaks, and for browning and crisping the roast skin.

Tips for grilling

- Grilling should be carried out with the oven door closed.
- Grilling tables indicate the recommended temperature, guide levels and grilling times, which may vary according to the weight and quality of meat.
- Grill heater should be pre-heated for 3 minutes.
- Oil the grill grid before placing the food, otherwise food might stick to the grid.
- Place the meat upon the grid, then place the grid upon the grease interception pan. Insert both trays into the oven guides.
- Turn the meat round after half of the grilling time has expired. Thinner slices will require only one turn, for larger chunks you might need to repeat the procedure. Always use barbecue tongs to avoid losing excessive juice from meat.
- Dark beef meat is grilled quicker than lighter pork or veal.
- Clean the grill, the oven and the accessories each time after use.

BAKING IN THE OVEN

Grill table

Type of meat for grill	Weight (in grams)	Shelf position (from bottom up)	Temp (°C)	Grill time (in min.)
Meat and sausages				
2 beefsteaks, rare	400	5	240	14-16
2 beefsteaks, medium	400	5	240	16-20
2 beefsteaks, well done	400	5	240	20-23
2 pork scrag fillets	350	5	240	19-23
2 pork chops	400	5	240	20-23
2 veal steaks	700	5	240	19-22
4 lamb cutlets	700	5	240	15-18
4 grill sausages	400	5	240	9-14
2 slices of meat cheese	400	5	240	9-13
1 chicken, halved	1400	3	240-250	28-33(1.side) 23-28(2.side.)
Fish				
Salmon fillets	400	4	240	19-22
Fish in aluminium foil	500	4	230	10-13
Toast				
4 slices of white bread	200	5	240	1,5-3
2 slices of whole meal	200	5	240	2-3
Toast sandwich	600	5	240	4-7
Meat/poultry				
Chicken	1000	3	180-200	60-70
Pork roast	1500	3	160-180	90-120
Pork scrag	1500	3	160-180	100-180
Pork knuckle	1000	3	160-180	120-160
Roast beef/ beef fillet	1500	3	190-200	40-80

TECHNICAL INFORMATION

TYPE	HOR54S5CW1
Dimensions (height/width/depth) cm	90/54/60
Oven	
Temperature regulator / function mode switch	1/1
Guide levels	5
Top/bottom heater(kW)	0.85/1.15
Grill heater(kW)	1.1
Oven illumination(W)	25
Function modes	
Top/bottom heater(kW)	2.0
bottom heater(kW)	1.15
Top heater(kW)	0.85
Separate oven lighting (W)	25
Bottom heater/fan(kW)	-
Top/grill (kW)	1.95
Grill heater(kW)	-
Max. temperature	250°C
Electric connection	220-240V/380-415 V 3N~,50Hz
Nominal voltage of heaters	220-240V
Total connected power(kW)	7.5
Oven total(kW)	2
Hotplate total(kW)	5.5

Complies with AS/NZS regulations EN 50304, AS/NZS60335-1,AS/NZS60335-2-6 standards.

ELECTRICAL CONNECTION

Caution!

All electrical work should be carried out by a suitably qualified and authorized electrician. No alterations or willful changes in the electricity supply should be carried out. The fixing line connected must be equipped with the all-pole disconnection device provided by breakaway the contact under overvoltage category III according to the the wiring rules.

Fitting guidelines

The cooker is manufactured to work with three-phase alternating current (380-415V 3N~50 Hz). The voltage rating of the cooker heating elements is 220-240V. Adapting the cooker to operate with one phase current is possible by appropriate bridging in the connection box according to the connection diagram below. The connection diagram is also found on the cover of the connection box. Remember that the connection wire should match the connection type and the power rating of the cooker.

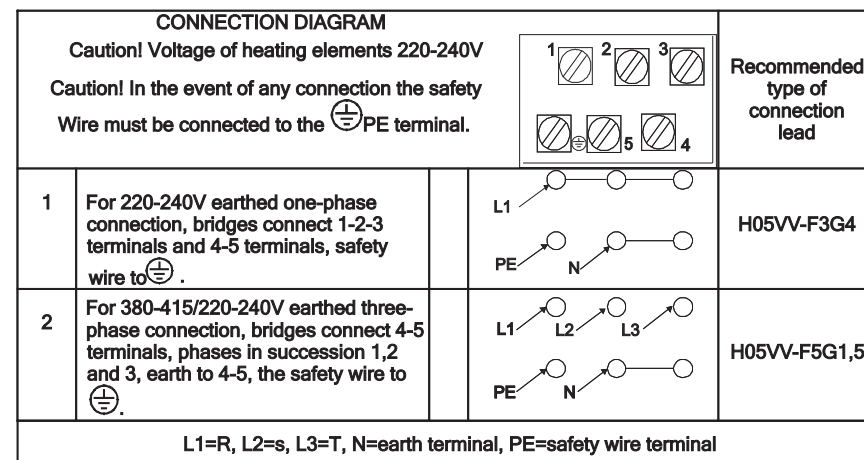

The connection cable must be secured in a strain-relief clamp.

Caution!

Remember to connect the safety circuit to the connection box terminal marked with PE.

Before connecting the cooker to the power supply it is important to read the information on the data plate and the connection diagram.