

MULTI-SPLIT AIR CONDITIONER INSTALLATION MANUAL

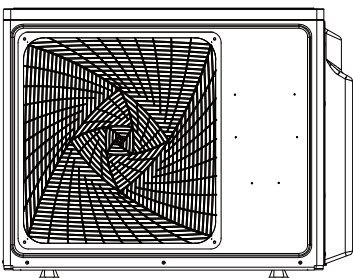

3U19FS2ERA

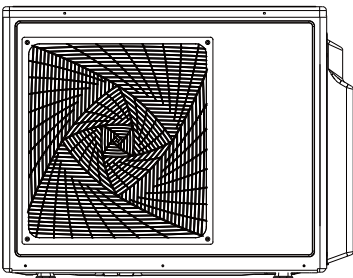

3U24GS2ERA

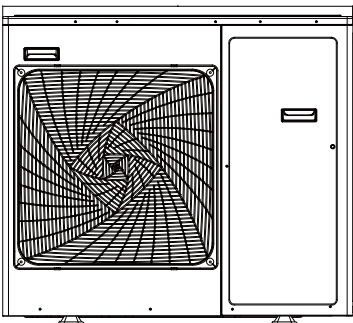

4U30HS2ERA
5U34HS2ERA

Contents

Safety Precautions	3
Accessories	4
Precautions for Selecting the Location	4
Installation drawings of indoor and outdoor units	5
Precautions on Installation	7
Outdoor Unit Installation Guideline	7
Limitations on the installation	7
Refrigerant piping work	7
Pump Down Operation	12
Wiring work	12
Test running	14
Dred function	15
Trouble shooting	16

No. 0150517641 B

- Please read this manual carefully before installation.
Keep this operation manual for future reference.

Haier

Haier Industrial Park, Qianwangang Road, Eco-Tech Development Zone, Qingdao 266555, Shandong, P.R.C.

DISPOSAL REQUIREMENTS:



Your air conditioning product is marked with this symbol. This means that electrical and electronic products shall not be mixed with unsorted household waste. Do not try to dismantle the system yourself: the dismantling of the air conditioning system, treatment of the refrigerant, of oil and of other part must be done by a qualified installer in accordance with relevant local and national legislation. Air conditioners must be treated at a specialized treatment facility for reuse, recycling and recovery. By ensuring this product is disposed of correctly, you will help to prevent potential negative consequences for the environment and human health. Please contact the installer or local authority for more information.

Battery must be removed from the remote controller and disposed of separately in accordance with relevant local and national legislation.

IMPORTANT INFORMATION REGARDING THE REFRIGERANT USED

Contains fluorinated greenhouse gases covered by the Kyoto Protocol

R410A	1 =	<input type="text"/>	kg
	2 =	<input type="text"/>	kg
	1+2 =	<input type="text"/>	kg

F E

This product contains fluorinated greenhouse gases covered by the Kyoto Protocol. Do not vent into the atmosphere.

Refrigerant type: R410A

GWP* value: 1975

GWP = global warming potential

Please fill in with indelible ink,

- 1 the factory refrigerant charge of the product
- 2 the additional refrigerant amount charged in the field and
- 1+2 the total refrigerant charge

on the refrigerant charge label supplied with the product. The filled out label must be adhered in the proximity of the product charging port (e.g. onto the inside of the stop valve cover).

A contains fluorinated greenhouse gases covered by the Kyoto Protocol

B factory refrigerant charge of the product: see unit name plate

C additional refrigerant amount charged in the field

D total refrigerant charge

E outdoor unit

F refrigerant cylinder and manifold for charging

⚠ WARNING

If the supply cord is damaged, it must be replaced by the manufacturer, its service agent or similarly qualified persons in order to avoid a hazard.

This appliance is not intended for use by persons (including children) with reduced physical, sensory or mental capabilities, or lack of experience and knowledge, unless they have been given supervision or instruction concerning use of the appliance by a person responsible for their safety.

Children should be supervised to ensure that they do not play with the appliance.

This appliance can be used by children aged from 8 years and above and persons with reduced physical, sensory or mental capabilities or lack of experience and knowledge if they have been given supervision or instruction concerning use of the appliance in a safe way and understand the hazards involved. Children shall not play with the appliance. Cleaning and user maintenance shall not be made by children without supervision.

The appliances are not intended to be operated by means of an external timer or separate remote-control system.

Keep the appliance and its cord out of reach of children less than 8 years.

The A-weighted sound pressure level is below 70 dB.

This appliance is intended to be used by expert or trained users in shops, in light industry and on farms, or for commercial use by lay persons

The power cable should be H05RN-F 3G 4.0mm².

Air conditioner working temperature: cooling 10~46 degree, heating -15~24 degree.



Safety Precautions

- Read these Safety Precautions carefully to ensure correct installation.
- This manual classifies the precautions into **WARNING** and **CAUTION**.
- Be sure to follow all the precautions below: they are all important for ensuring safety.

 **WARNING** Failure to follow any of **WARNING** is likely to result in such grave consequences as death or serious injury.

 **CAUTION** Failure to follow any of **CAUTION** may in some cases result in grave consequences.

- The following safety symbols are used throughout this manual:

 Be sure to observe this instruction  Be sure to establish an earth connection  Never attempt

- After completing installation, test the unit to check for installation errors. Give the user adequate instructions concerning the use and cleaning of the unit according to the Operation Manual.

WARNING





- Installation should be left to the dealer or another professional.
Improper installation may cause water leakage, electrical shock, or fire.
- Install the air conditioner according to the instructions given in this manual.
Incomplete installation may cause water leakage, electrical shock, or fire.
- Be sure to use the supplied or specified installation parts.
Use of other parts may cause the unit to come loose, water leakage, electrical shock, or fire.
- Install the air conditioner on a solid base that can support the unit's weight.
An inadequate base or incomplete installation may cause injury in the event the unit falls off the base.
- Electrical work should be carried out in accordance with the installation manual and the national electrical wiring rules or code of practice.
Insufficient capacity or incomplete electrical work may cause electrical shock or fire.
- Be sure to use a dedicated power circuit. Never use a power supply shared by another appliance.
- For wiring, use a cable long enough to cover the entire distance with no connection.
Do not use an extension cord. Do not put other loads on the power supply, use a dedicated power circuit.
(Failure to do so may cause abnormal heat, electric shock or fire.)
- Use the specified types of wires for electrical connections between the indoor and outdoor units.
Firmly clamp the interconnecting wires so their terminals receive no external stresses. Incomplete connections or clamping may cause terminal overheating or fire.
- After connection interconnecting and supply wiring be sure to shape the cables so that they do not put undue force on the electrical covers or panels.
Install covers over the wires. Incomplete cover installation may cause terminal overheating, electrical shock, or fire.
- If any refrigerant has leaked out during the installation work, ventilate the room.
(The refrigerant produces a toxic gas if exposed to flames.)
- After all installation is complete, check to make sure that no refrigerant is leaking out.
(The refrigerant produces a toxic gas if exposed to flames.)
- When installing or relocating the system, be sure to keep the refrigerant circuit free from substances other than the specified refrigerant(R410A), such as air.
(Any presence of air or other foreign substance in the refrigerant circuit causes an abnormal pressure rise or rupture, resulting in injury.)
- During pump-down, stop the compressor before removing the refrigerant piping.
If the compressor is still running and the stop valve is open during pump-down, air will be sucked in when the compressor is run, causing abnormal pressure in the freezer cycle which will lead to breakage and even injury.
- Be sure to establish an earth. Do not earth the unit to a utility pipe, arrester, or telephone earth.
In complete earth may cause electrical shock, or fire. A high surge current from lightning or other sources may cause damage to the air conditioner. 
- Be sure to install an earth leakage breaker.
Failure to install an earth leakage breaker may result in electric shocks, or fire.

CAUTION

- Do not install the air conditioner in a place where there is danger of exposure to inflammable gas leakage. 
If the gas leaks and builds up around the unit, it may catch fire.
- Establish drain piping according to the instructions of this manual.
Inadequate piping may cause flooding.
- Tighten the flare nut according to the specified method such as with a torque wrench.
If the flare nut is tightened too hard, the flare nut may crack after a long time and cause refrigerant leakage.
- Make sure to provide for adequate measures in order to prevent that the outdoor unit be used as a shelter by small animals.
Small animals making contact with electrical parts can cause malfunctions, smoke or fire. Please instruct the customer to keep the area around the unit clean.

Accessories

Accessories supplied with the outdoor unit:

No.	Drawing	Name of parts	Quantity	Note
1		Drainage elbow	1	3U19FS2ERA 3U24GS2ERA
			3	4U30HS2ERA 5U34HS2ERA
2		Rubber cushion	4	3U19FS2ERA 4U30HS2ERA 3U24GS2ERA 5U34HS2ERA
3		Clamp	1	3U19FS2ERA 3U24GS2ERA
			3	4U30HS2ERA 5U34HS2ERA
4		Adaptor(3/8→1/2)	1	3U19FS2ERA 4U30HS2ERA 3U24GS2ERA 5U34HS2ERA
5		Adaptor(1/2→3/8)	1	4U30HS2ERA 5U34HS2ERA

Procedure for Selecting the Location

- 1) Choose a place solid enough to bear the weight and vibration of the unit, where the operation noise will not be amplified.
- 2) Choose a location where the hot air discharged from the unit or the operation noise, will not cause a nuisance to the neighbors of the user.
- 3) Avoid places near a bedroom and the like, so that the operation noise will cause no trouble.
- 4) There must be sufficient space for carrying the unit into and out of the site.
- 5) There must be sufficient space for air passage and no obstructions around the air inlet and the air outlet.
- 6) The site must be free from the possibility of flammable gas leakage in a nearby place.
Locate the unit so that the noise and the discharged hot air will not annoy the neighbors.
- 7) Install units, power cords and inter-unit cables at least 10ft away from television and radio sets. This is to prevent interference to images and sounds. (Noises may be heard even if they are more than 10ft away depending on radio wave conditions.)
- 8) In coastal areas or other places with salty atmosphere of sulfate gas, corrosion may shorten the life of the air conditioner.
- 9) Since drain flows out of the outdoor unit, do not place under the unit anything which must be kept away from moisture.
- 10) On a flat surface that does not collect rain water.
- 11) Away from strong wind.
- 12) Away from direct exposure to rain or snow.
- 13) Away from sea breeze.
- 14) Away from inflammable materials.

NOTE:

- 1) Cannot be installed hanging from ceiling or stacked.
- 2) If installing on a high place such as a roof, with a fence or guard rail around it.
- 3) If there is a potential for accumulated snow to block the air inlet or heat exchanger, install the unit on a higher base.
- 4) R-410A refrigerant is a safe, nontoxic and nonflammable refrigerant. However, if there is a concern about a dangerous level of refrigerant concentration in the case of refrigerant leakage, add extra ventilation.
- 5) Avoid installing the outdoor unit where corrosive gases, such as sulfur oxides, ammonia, and sulfurous gas, are produced. If unavoidable, consult with an installation specialist about using a corrosion-proof or anti-rust additive to protect the unit coils.
- 6) For seacoast applications, block the unit from direct exposure to sea breeze by installing the unit behind a structure (such as a building) or a protective wall that is 1.5 times higher than the unit, leaving 28 in. (700 mm) of space between the wall and unit for air circulation. Consult an installation expert about taking anti-corrosion measures, such as removing salinity on the heat exchanger and applying a rust inhibitor more frequently than once a year.

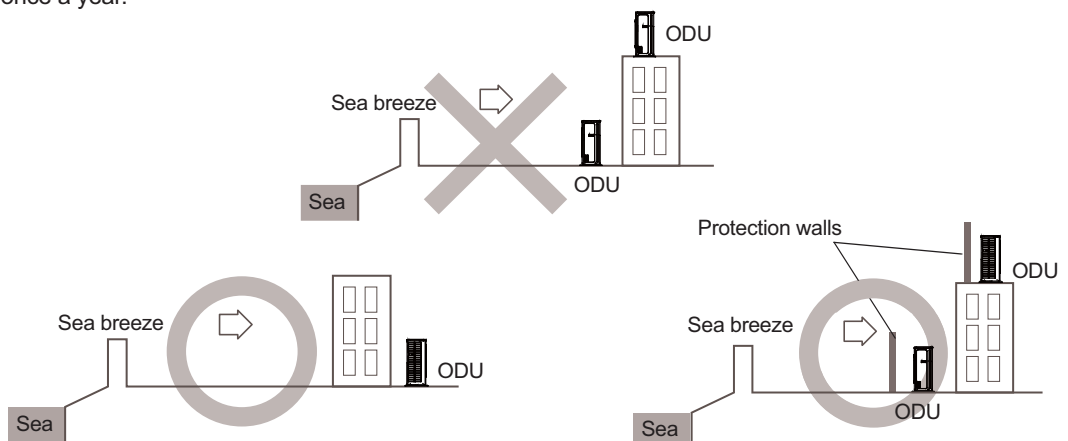

Installation drawings of indoor and outdoor units

1. Do not connected the embedded branch piping and the outdoor unit when only carrying out piping work without connecting the indoor unit in order to add another indoor unit later. Make sure no dirt or moisture gets into either side of the embedded branch piping.
2. It is impossible to connect the indoor unit for one room only.

Installation figure please refers to 4U30HS2ERA.

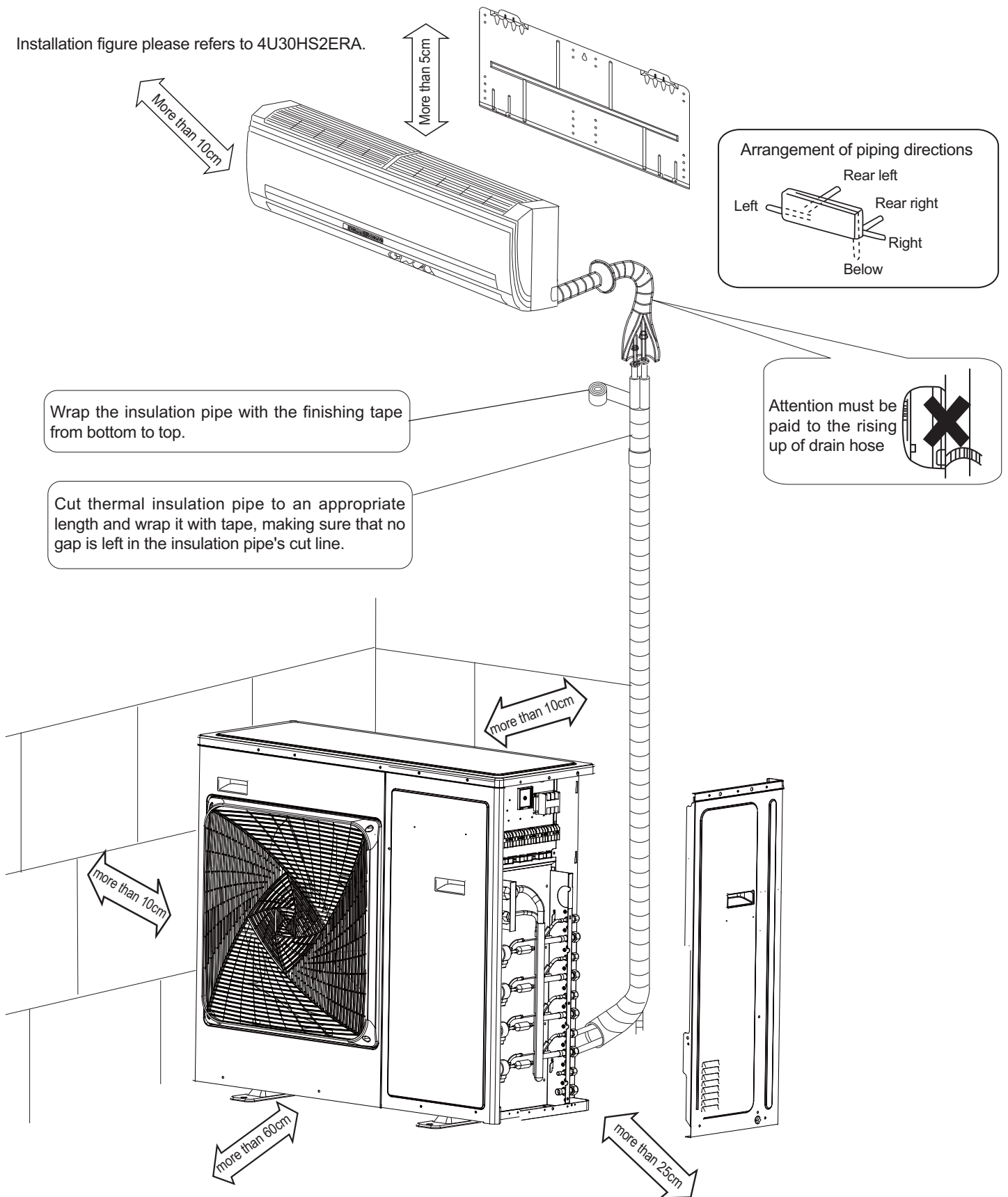

If there is the danger of the unit falling or overturning, fix the unit with foundation bolts, or with wire or other means.
 If the location does not have good drainage, place the unit on a level mounting base (or a plastic pedestal).
 Install the outdoor unit in a level position. Failure to do so may result in water leakage or accumulation.

Installation drawings of indoor and outdoor units

Connection cautions

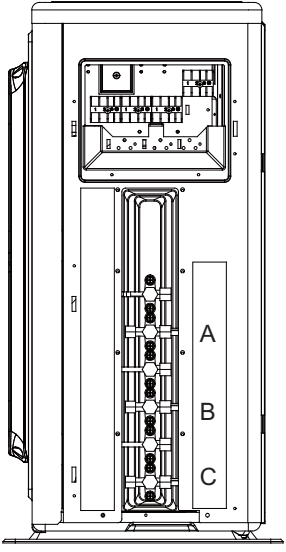
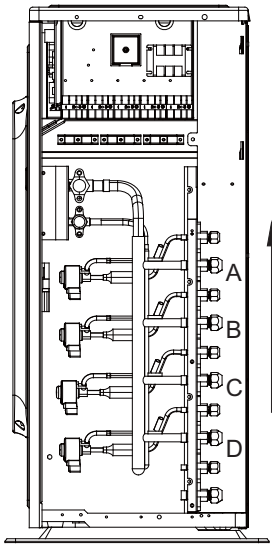
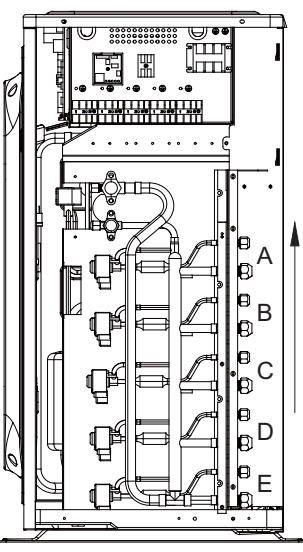
model	3U19FS2ERA 3U24GS2ERA	4U30HS2ERA	5U34HS2ERA
connection priority between indoor and stop valve higher from down to up			
when there is 1 indoor,the prior stop valve is	C	D	E
when there are 2 indoors,the prior stop valves are	C B	D C	E D
when there are 3 indoors,the prior stop valves are	C B A	D C B	E D C
when there are 4 indoors,the prior stop valves are		D C B A	E D C B
when there are 5 indoors,the prior stop valves are			E D C B A
Note: For better oil return and more reliable system, please execute as the above when connecting indoor unit.			

Precautions on Installation

- Check the strength and level of the installation ground so that the unit will not cause any operating vibration or noise after installed.
- In accordance with the foundation drawing in fix the unit securely by means of the foundation bolts. (Prepare four sets of M8 or M10 foundation bolts, nuts and washers each which are available on the market.)
- It is best to screw in the foundation bolts until their length are 20mm from the foundation surface.

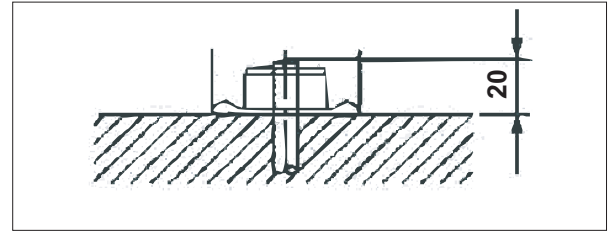

Outdoor Unit Installation Guideline

- Where a wall or other obstacle is in the path of outdoor unit's intake or exhaust airflow, follow the installation guidelines below.
- For any of the below installation patterns, the wall height on the exhaust side should be 1200mm or less.

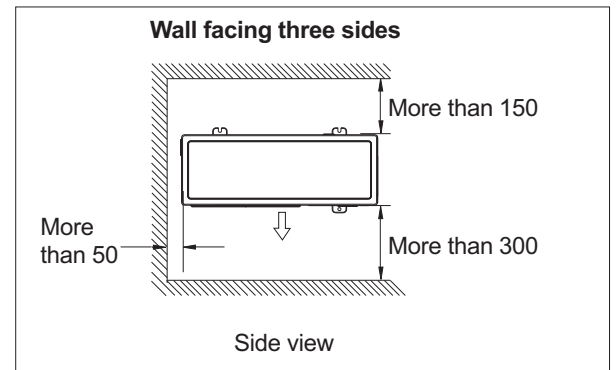
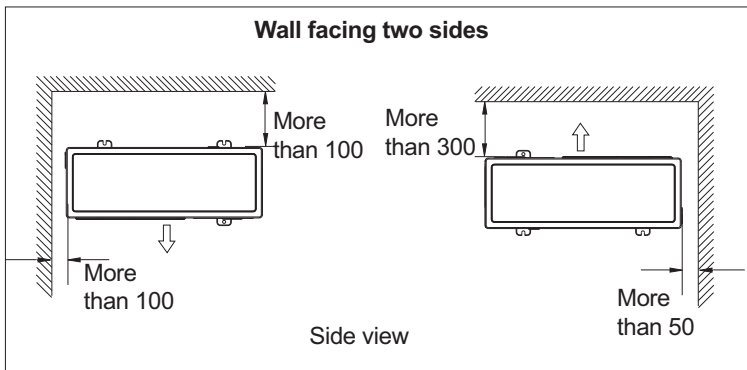
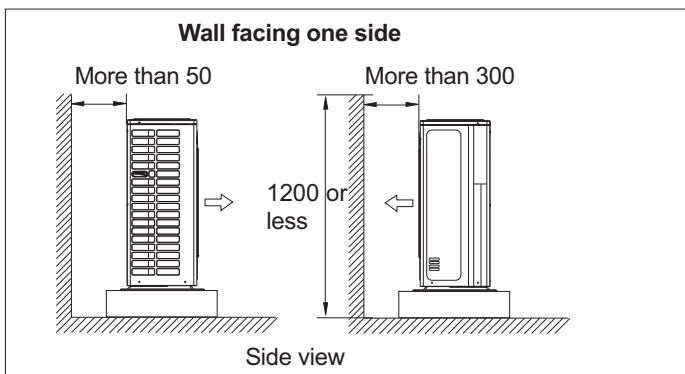

Limitations on the installation

1. Precautions on installation

- Check the strength and level of the installation ground so that unit will not cause any operating vibration or noise after installation.
- In accordance with the foundation drawing in fix the unit securely by means of the foundation bolts.
- It is best to screw in the foundation bolts until their length are 20 mm from the foundation surface.

2. Selecting a location for installation of the indoor units

- The maximum allowable length of refrigerant piping, and the maximum allowable height difference between the outdoor and indoor units, are listed below. (The shorter the refrigerant piping, the better the performance. Connect so that the piping is as short as possible. Shortest allowable length per room is 3m)

Outdoor unit capacity class	3U19FS2ERA	3U24GS2ERA	4U30HS2ERA	5U34HS2ERA
Piping to each indoor unit	25m max.	25m max.	25m max.	25m max.
Total length of piping between all units	50m max.	60m max.	70m max.	80m max.

Limitations on the installation

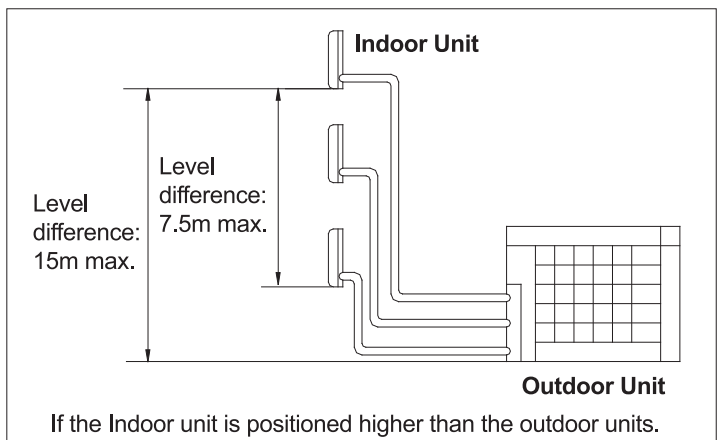
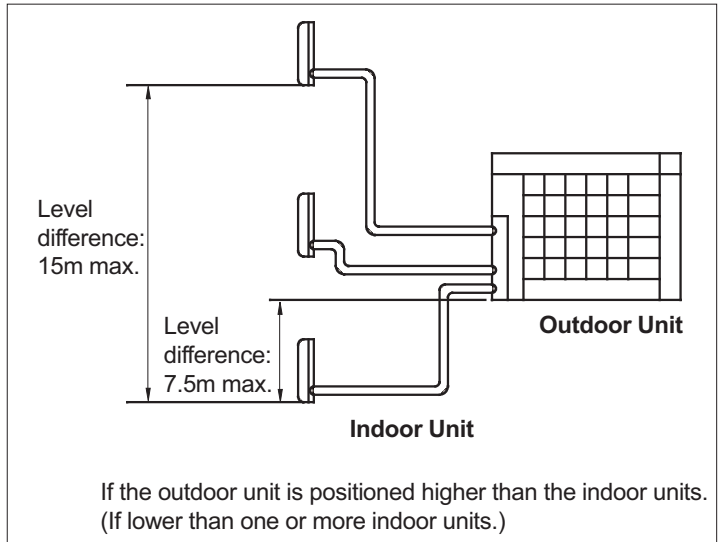
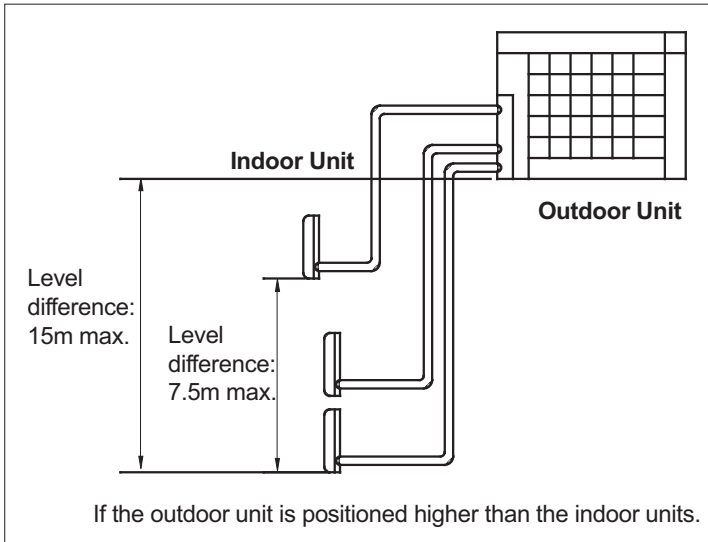

Refrigerant piping work

1. Installing outdoor unit

- 1) When installing the outdoor unit, refer to "Precautions for Selecting the Location" and the "Indoor/Outdoor Unit Installation Drawings".
- 2) If drain work is necessary, follow the procedures below.

2. Drain work

- 1) Use drain plug for drainage.
- 2) If the drain port is covered by a mounting base or floor surface, place additional foot bases of at least 30mm in height under the outdoor unit's feet.
- 3) In cold areas, do not use a drain hose with the outdoor unit. (Otherwise, drain water may freeze, impairing heating performance.)

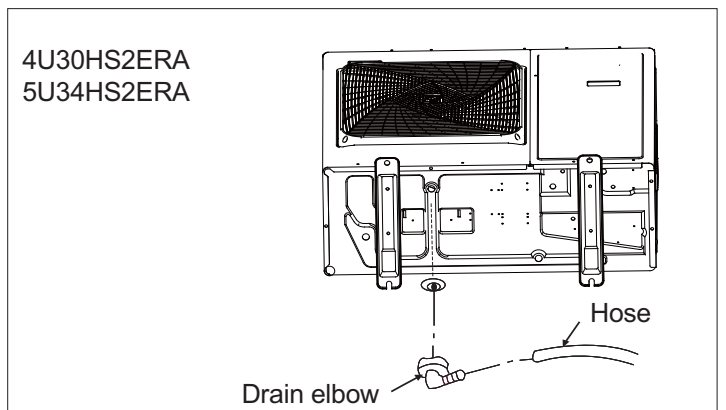
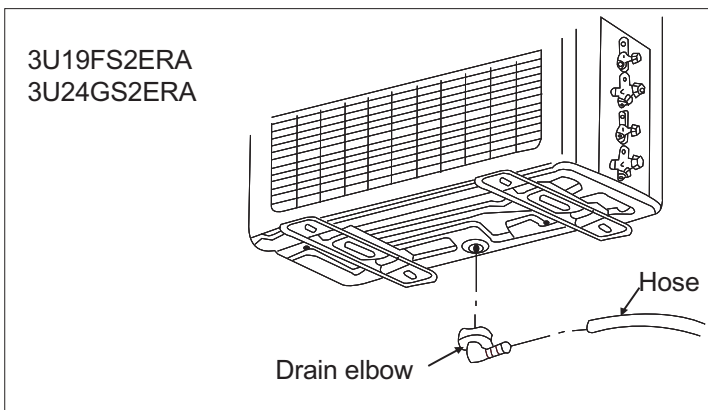

Refrigerant piping work

3. Refrigerant piping work

- Align the centres of both flares and tighten the flare nuts 3 or 4 turns by hand. Then tighten them fully with the tor wrenches. Use torque wrenches when tightening the flare nuts to prevent damage to the flare nuts and escaping gas.

Flare nut tightening torque	
Flare nut for \varnothing 6.35	14.2-17.2N.m(144-175kgf.cm)
Flare nut for \varnothing 9.52	32.7-39.9N.m(333-407kgf.cm)
Flare nut for \varnothing 12.7	49.5-60.3N.m(505-615kgf.cm)
Flare nut for \varnothing 15.88	61.8-75.4N.m(630-769kgf.cm)

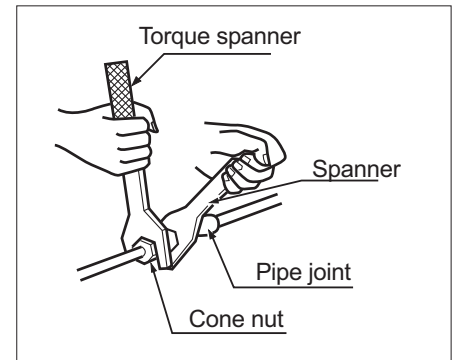
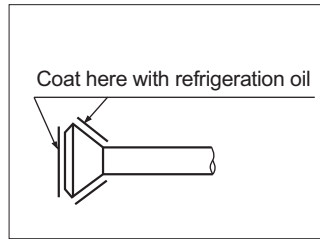

Valve cap tightening torque	
Liquid pipe	26.5-32.3N.m(270-330kgf.cm)
Gas pipe	48.1-59.7N.m(490-610kgf.cm)

Service port cap tightening torque	
10.8-14.7N.m(110-150kgf.cm)	

- To prevent gas leakage, apply refrigeration oil on both inner and outer surfaces of the flare. (Use refrigeration oil for R410A)

4. Purging air and checking gas leakage

When piping work is completed, it is necessary to purge the air and check for gas leakage.

WARNING

- Do not mix any substance other than the specified refrigerant (R410A) into the refrigeration cycle.
- When refrigerant gas leaks occur, ventilate the room as soon and as much as possible.
- R410A, as well as other refrigerants, should always be recovered and never be released directly into the environment.
- Use a vacuum pump for R410A exclusively. Using the same vacuum pump for different refrigerants may damage the vacuum pump or the unit.

- If using additional refrigerant, perform air purging from the refrigerant pipes and indoor unit using a vacuum pump, then charge additional refrigerant.
- Use a hexagonal wrench (4mm) to operate the stop valve rod.
- All refrigerant pipe joints should be tightened with a torque wrench at the specified tightening torque.

Connect projection side of charging hose(Which comes from gauge manifold) to gas stop valve's service port.



Fully open gauge manifold's low-pressure valve(Lo) and completely close its high-pressure valve(Hi).
(High-pressure valve subsequently requires no operation.)



Apply vacuum pumping. Check that the compound pressure gauge reads-0.1MPa(-76cmHg).
Evacuation for at least 1 hour is recommended.



Close gauge manifold's low-pressure valve(Lo) and stop vacuum pump.
(Leave as is for 4-5 minutes and make sure the coupling meter needle does not go back.
If it does go back, this may indicate the presence of moisture or leaking from connecting parts. After inspecting all the connection and loosening then retightening the nuts, repeat steps 2-4.)



Remove covers from liquid stop valve and gas stop valve.



Turn the liquid stop valve's rod 90 degrees counterclockwise with a hexagonal wrench to open valve.
Close it after 5 seconds, and check for gas leakage.
Using soapy water, check for gas leakage from indoor unit's flare and outdoor unit's flare and valve rods.
After the check is complete, wipe all soapy water off.



Disconnect charging hose from gas stop valve's service port, then fully open liquid and gas stop valves.
(Do not attempt to turn valve rod beyond its stop.)



Tighten valve caps and service port caps for the liquid and gas stop valves with a torque wrench at the specified torques. See "3 Refrigerant piping " on page 6 for details.

Refrigerant piping work

5. Refilling the refrigerant

Check the type of refrigerant to be used on the machine nameplate.

Precautions when adding R410A

Fill from the liquid pipe in liquid form.

It is a mixed refrigerant, so adding it in gas form may cause the refrigerant composition to change, preventing normal operation.

1) Before filling, check whether the cylinder has a siphon attached or not. (It should have something like "liquid filling siphon attached" displayed on it.)

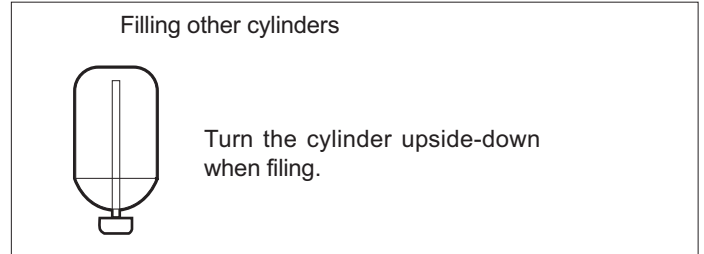
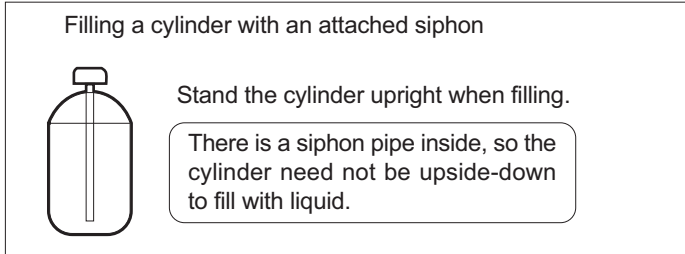

2) Be sure to use the R410A tools to ensure pressure and to prevent foreign objects entering.

6. Charging with refrigerant

- 1) This system must use refrigerants R410A.
- 2) Add refrigerant 20g per meter when the total piping length exceeds the standard value, but make sure that the total liquid piping length should be less than the max. value. 5U45LS1ERA charge 28g/m refrigerant for extra pipe length

Outdoor Unit	Standard total liquid piping length	Max. total liquid piping length
3U19FS2ERA	30m	50m
3U24GS2ERA	30m	60m
4U30HS2ERA	40m	70m
5U34HS2ERA	40m	80m

Notes:

- 1) When using this product, you need not to set the address. But the L/N wires between indoor & outdoor units must be corresponded, or there will be communication failure.
- 2) Quiet Operation Setting. Set the DIP "8" to ON position of SW5, the system will run with lower noise, but the max. capacity will also reduce slightly.
- 3) Do not change the settings of other switches, wrong settings can make the system damage or other malfunctions.

7. Precautions for Laying Refrigerant Piping

• Cautions on pipe handling

- 1) Protect the open end of the pipe against dust and moisture.
- 2) All pipe bends should be as gentle as possible. Use a pipe bender for bending. (Bending radius should be 30 to 40mm or larger.)

• Selection of copper and heat insulation materials

When using commercial copper pipes and fittings, observe the following :

- 1) Insulation material: Polyethylene foam
Heat transfer rate: 0.041 to 0.052W/mK(0.035to 0.045kcal/mh°C)
Refrigerant gas pipe's surface temperature reaches 110°C max.
Choose heat insulation materials that will withstand this temperature.
- 2) Be sure to insulate both the gas and liquid piping and to provide insulation dimensions as below.

Gas pipe	Gas pipe insulation
O.D.:9.52mm,12.7mm Thickness:0.8mm	I.D.:12-15mm,12.7mm Thickness:13mm min.
Liquid pipe	Liquid pipe insulation
O.D.:6.35mm Thickness:0.8mm	I.D.:18-10mm Thickness:10mm min.

Refrigerant Piping Work

3) Use separate thermal insulation pipes for gas and liquid refrigerant pipe.

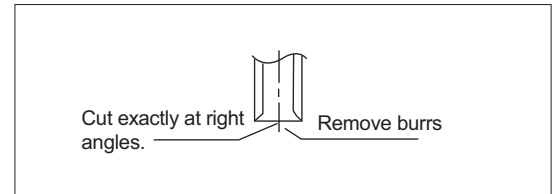
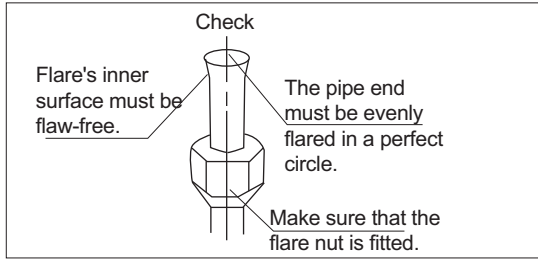
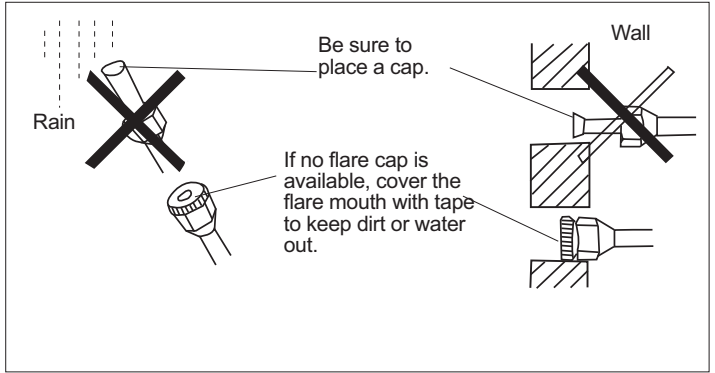
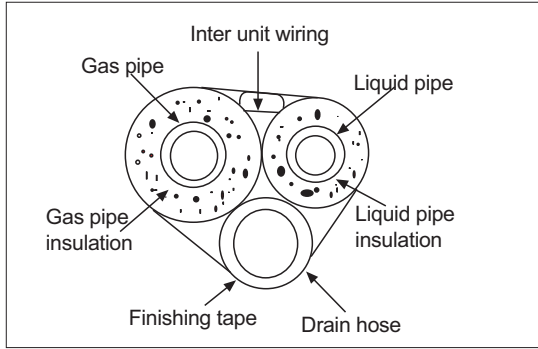

Set exactly at the position shown below.

 Flare tooling die	Flare tool for R410A	Conventional flare tool	
	Clutch-type	Clutch-type(Rigid-type)	Wing-nuttype(Imperial-type)
	0-0.5mm	1.0-1.5mm	1.5-2.0mm

8. Cutting and Flaring work of piping

- Pipe cutting is carried out with a pipe cutter and burrs must be removed.
- After inserting the flare nut, flaring work is carried out.

 Flare tooling die	Pipe	Pipe diameter ϕ	Size A (mm)
	Liquid side	6.35mm(1/4")	0.8~1.5
	Gas side	9.52mm(3/8")	1.0~1.5
		12.7mm(1/2")	1.0~1.5

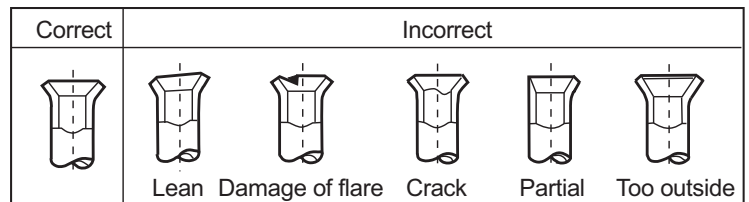

9. On drainage

- Please install the drain hose so as to be downward slope without fail. Please don't do the drainage as shown below.

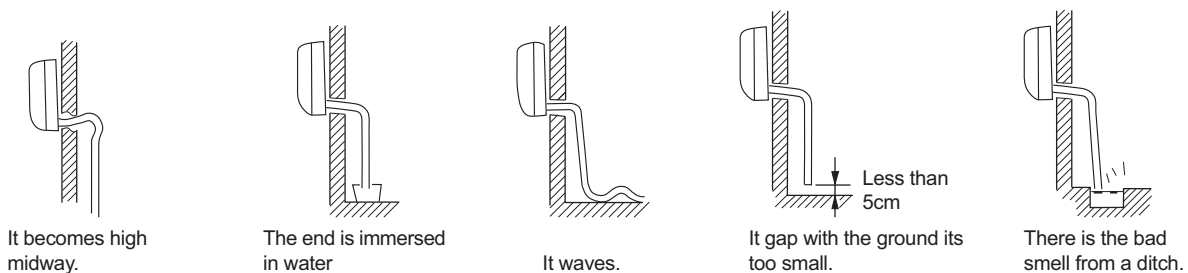

- Please pour water in the drain pan of the indoor unit, and confirm that drainage is carried out serely to outdoor.
- In case that the attached drain hose is in a room, please apply heat insulation to it without fail.

⚠ WARNING

- 1) Do not use mineral oil on flared part.
- 2) Prevent mineral oil from getting into the system as this would reduce the lifetime of the units.
- 3) Never use piping which has been used for previous installations. Only use parts which are delivered with the unit.
- 4) Do never install a drier to this R410A unit in order to guarantee its lifetime.
- 5) The drying material may dissolve and damage the system.
- 6) Incomplete; ete flaring may cause refrigerant gas leakage.

Pump Down Operation

In order to protect the environment, be sure to pump down when relocating or disposing of the unit.

- 1) Remove the valve caps from liquid stop valve and gas stop valve.
- 2) Carry out forced cooling operation.
- 3) After five to ten minutes, close the liquid stop valve with a hexagonal wrench.
- 4) After two to three minutes, close the gas stop valve and stop forced cooling operation.

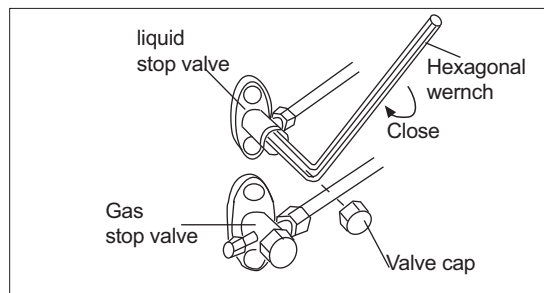

Wiring work

1. Electric wiring

- The air conditioner must use special circuit, and wiring by the qualified electrician according to the wiring rules specified in national standard.
- The grounding wire and the neutral wire shall be strictly separated. Connect the neutral wire with grounding wire is incorrect.
- The electric leakage breaker must be installed.
- All the electric wire must be copper wire. Power supply: 1PH, 220-240V~, 50/60Hz.
- The wiring method of power line is Y connection. If the power line is damaged, in order to avoid risk of electric shock, it must be replaced by the manufacturer or its repair center or other similar qualified person. The connecting cable must be shielded.
Fuse: T3.15A 250VAC(Electronic control unit) T25A 250VAC(Power circuit board).
- Please check the circuit diagram about the fuse replaced.

2. Wiring method

- Wiring method of orbicular terminals
For the connection wire with orbicular terminals, its wiring method is as shown in the right figure: remove the connecting screw, put the screw through the ring on the end of the wire, then connect to the terminal block and fasten screw.
Wiring method of straight terminals.
• For the connection wire without orbicular terminals, its wiring method is: loosen the connection screw, and insert the end of the connection wire completely into the Terminal block, then fasten the screw.
Slightly pull the wire outwards to confirm it is firmly held.

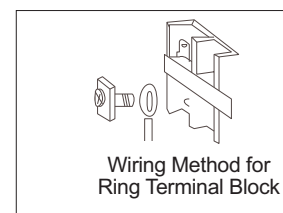

- Crimp connection method for wires without terminals

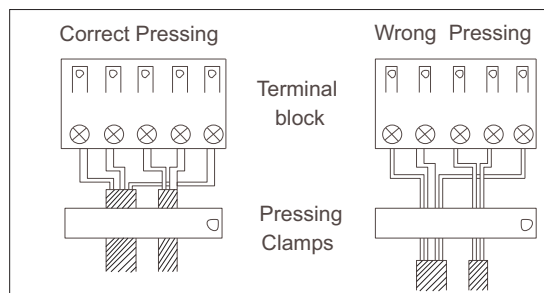
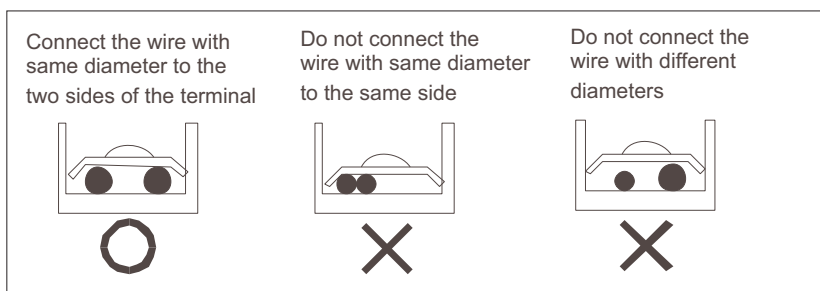

- Crimp connection method for connection wire
After connection, the wire must be fastened by wire cover. The wire cover shall press on the protection coat of the connection wire, as shown in right top figure.
Note: When connecting the wiring, confirm the terminal number of indoor and outdoor units carefully. Incorrect wiring will damage the controller of air conditioner or the unit can not operate.

3. Wiring method of outdoor unit:

- Power line
Remove the repair board of the outdoor unit and loosen the wire cover A, then put the live wire, neutral wire and grounding wire through the wire cover, and connect them to terminal block correspondingly. After connection, fasten wire cover to its previous state.
Communication wire of indoor unit.
- Loosen wire cover, put the communication wire through the wire cover B, and connect them to terminal block correspondingly. After connection, fasten wire cover B to its previous state.

Note: Power line and communication wire are provided by consumers themselves.

Wiring work

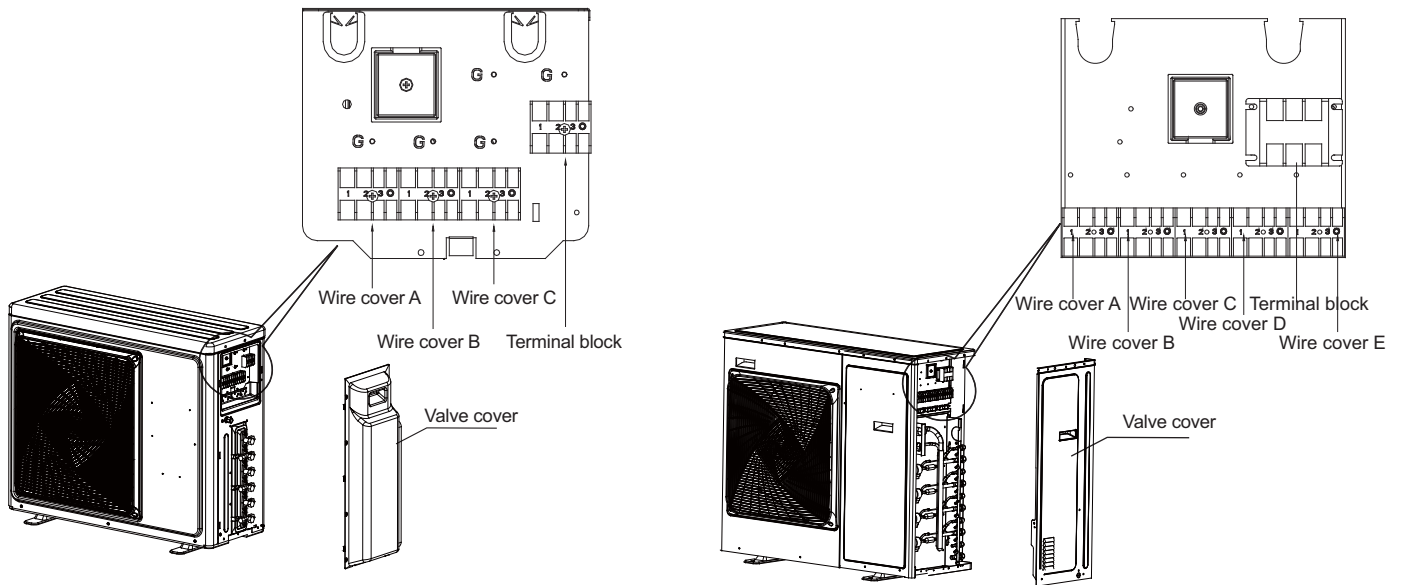

4. Wiring method of indoor unit

Loosen wire cover and connect the power line and communication wire of indoor unit to the terminal correspondingly.

Note:

When connecting power line to power supply terminal, please pay attention to the following items:

- Do not connect the power line with different dimensions to the same connection wire end. Improper contact will cause heat generation.
- Do not connect the power line with different dimensions to the same grounding wire end. Improper contact will affect protection.
- Do not connect the power line to the connecting end of communication wire. Incorrect connection will cause damage to the connected unit.

5. Example wiring diagram.

Wiring diagram please refers to 5U34HS2ERA

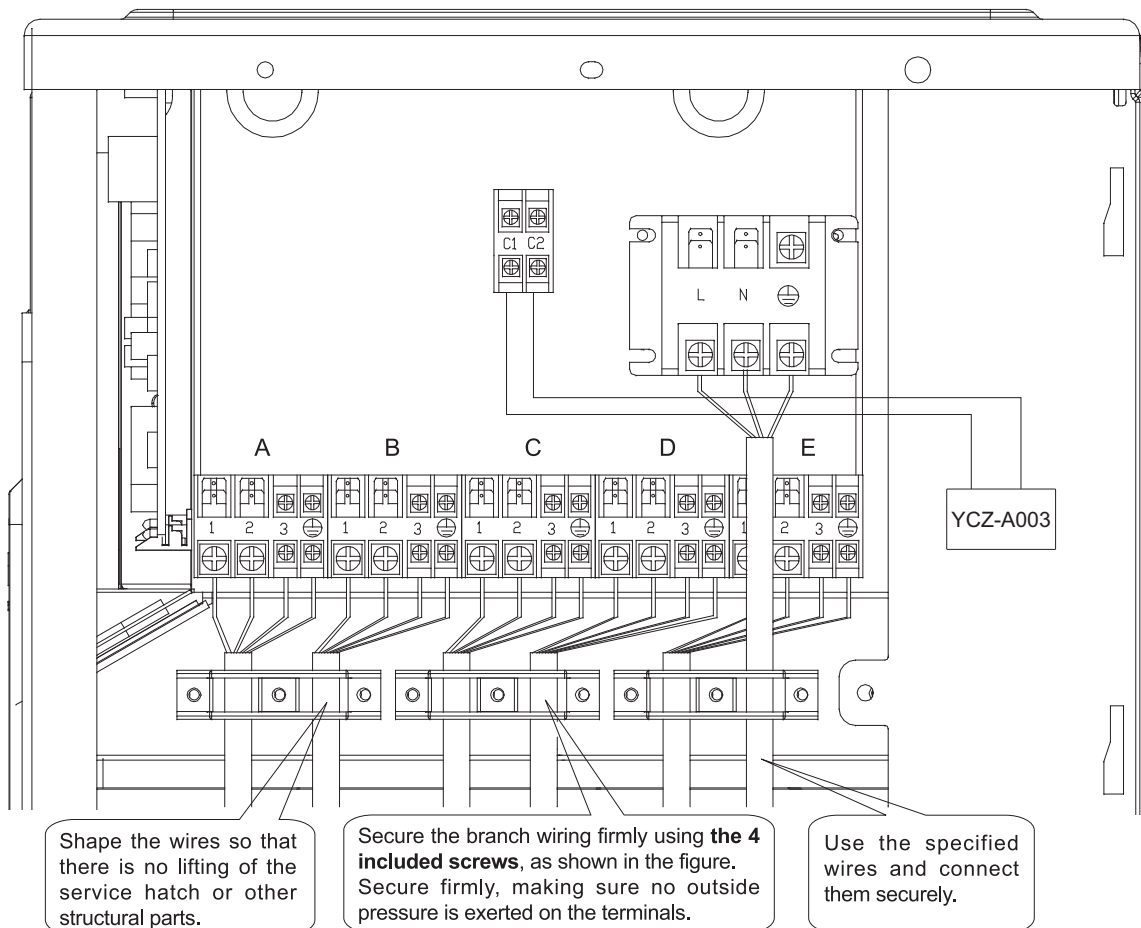

Test running

- Before starting the test running, please confirm the following works have been done successfully.
 - 1) Correct piping work;
 - 2) Correct wiring work;
 - 3) Correct match of indoor and outdoor unit;
 - 4) Proper recharge of refrigerant if needed.
- Make sure that all the stop valves are fully open.
- Check the voltage supplied to the outdoor and indoor units, please confirm that is 230V.

• Wiring Error Check

This product is capable of automatic checking of wiring error.

Switch on all the 4 dip-switches on the outdoor unit small service PC-board as shown on the right. Then power off the unit and power on again, the system will enter the operation of "Wiring Error Check". After 3 minutes stand-by, the unit starts for automatic wiring checking.

Approximately 30 ~ 50minutes (depends on how many units installed in the system) after the unit starts, the Errors of the wiring will be shown by the LEDs (1 to 5).

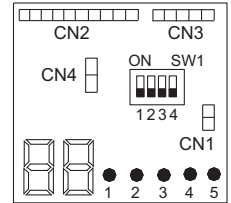

During this operation, the digital-number will alternately show the compressor working frequency (e.g. 50 stands for the current running frequency) and letter "CH"(means checking).

After this operation, if all the wiring is correct, the digital-number will show "0", if there has wrong wiring, the digital-number will show "EC"(error connection) and also it will flashing.

The service monitor LEDs indicate the error of wiring, as shown in the table below. For details about how to read the LED display, refer to the service manual.

If self-checking is not possible, check the indoor unit wiring and piping in the usual manner.

LED	1	2	3	4	5	Message
Status	OFF					Unit not connected
	ALL Flashing					Automatic checking impossible, all units connect wrong
	ALL ON					All units connect correctly
	ON	FLASHING	FLASHING	ON	FLASHING	ON: unit connect correctly FLASHING: unit connect wrong, need to change the wiring manually between 2,3,and 5
	ON	FLASHING	FLASHING	ON	ON	ON: unit connect correctly FLASHING: unit connect wrong, need to change the wiring manually between 2,3
Only one LED flashing					Abnormal	

• Test running.

- 1) If the temperature is lower than 16 °C, it is impossible to test cooling with remote controller, and also when the temperature is higher than 30 °C, it is impossible to test heating.
- 2) To test cooling, set the lowest temperature at 16 °C. To test heating, set the highest temperature, at 30 °C.
- 3) Please check both cooling and heating operation of each unit individually and then also check the simultaneous operation of all indoor units.
- 4) After running the unit for about 20 minutes, check the indoor unit outlet temperature.
- 5) After the unit is stopped, or working mode changed, the system will not start again for about 3 minutes.
- 6) During cooling operation, frost may occur on the indoor unit or pipes, this is normal.
- 7) Operate the unit according to the operation manual. Please kindly explain to our customers how to operate through the instruction manual.

• Seven-segment numeric display

1) When unit is running, this seven-segment numeric will display the frequency of compressor. For example, "40" means compressor running frequency is 40 Hz, "108" means compressor running frequency is 108Hz.

2) When faulty happens, seven-segment numeric will flash and display some numbers, this number is failure code. For example, a flashing "32" means No.32 failure, that is indoor and outdoor communication error.

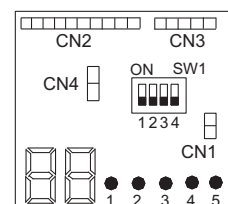

• Communication LED

5 green LED means 5 indoor units. If one LED keep lighting that means the corresponding indoor unit has good communication with outdoor unit. If one LED is not lighting, that means there is no communication between indoor and outdoor.

Dred function

Please consult your reseller and/or installer to determine if you have a DRED device.
Connect output from your DRED device (where available) to the RJ45connector on the outdoor unit, as shown.

1. Open cover piece and locate the fixed DRM cable.

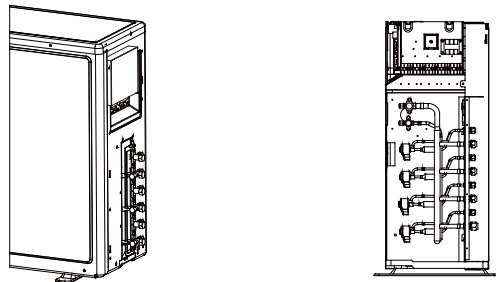

2.

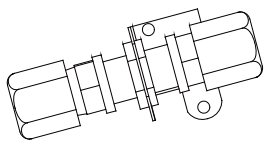

a

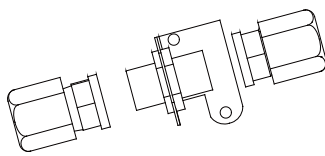

b

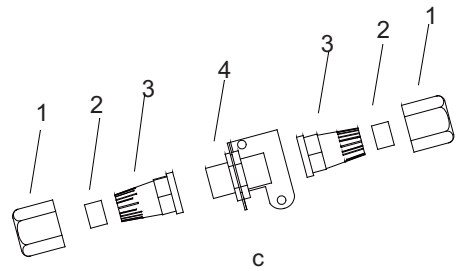

c

- Take out DRED module from indoor packing bag.
- Separate DRED module to 3 parts as shown.
- Continue to separate the DRED module to 7 parts as shown

3.

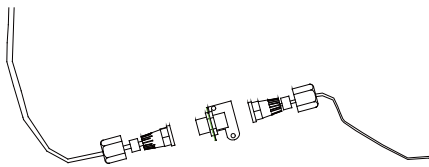

a

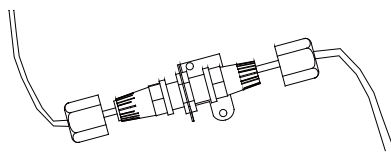

b

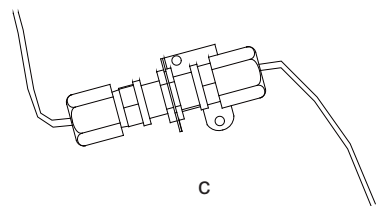

c

- Fix Pin 1 for contractor supplied line through nut 1, seal ring 2, tapered cup nut 3 insert to stud 4.
- Repeat step 1 for fixed DRM line.
- Tighten the screw position on both sides.

4.

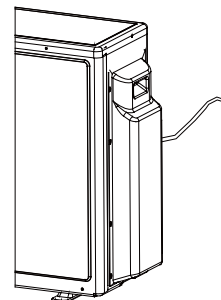
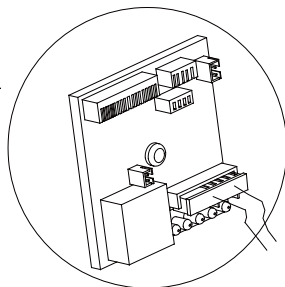
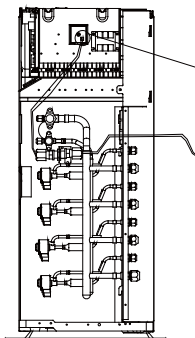
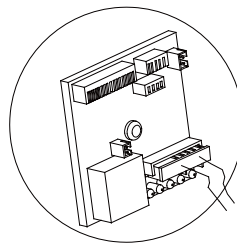
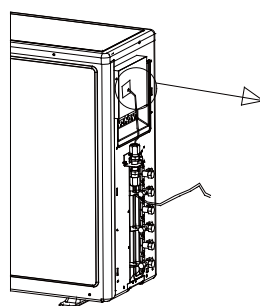
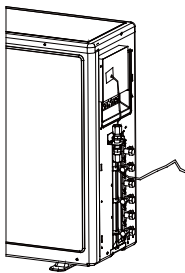

- Tighten the DRED module to right side plate.
- Tighten the screw .
- Insert the DRED terminal into the 5 core ports in PCB , check the picture.
- Refit the trim cover.

Trouble shooting

Possible reasons	Outdoor LED display	Wired controller display	Cassette and convertible indoor display outdoor error code use the timer and running lamp	
			Timer lamp flash time	Running lamp flash time
Faulty of outdoor unit EEPROM	1	15	2	1
IPM overcurrent or short circuit	2	16	2	2
Communication failure between Module and ECU	4	18	2	4
Module operated overload	5	19	2	5
Module low or high voltage	6	1A	2	6
Discharging temperature overheating.Lack of refrigerant, ambient temperature too high or PMVs blocked.	8	1C	2	8
Malfunction of the DC fan motor	9	1D	2	9
Malfunction of defrosting temp. sensor	10	1E	3	0
Malfunction of compressor suction temp. sensor	11	1F	3	1
Malfunction of ambient temp. sensor	12	20	3	2
Malfunction of compressor discharge temp. sensor	13	21	3	3
Communication failure between indoor&outdoor unit	15	23	3	5
Lack of refrigerant or discharging pipe blocked	16	36	3	6
4-way valve switching failure	17	25	3	7
Loss of synchronism detection	18	26	3	8
Indoor thermal overload	20	28	4	0
Indoor frosted	21	29	4	1
Module thermal overload	23	2B	4	3
Compressor start failure	24	2C	4	4
Module input overcurrent	25	2D	4	5
MCU reset	26	2E	4	6
Module input current detect circuit malfunction	27	2F	4	7
Malfunction of liquid pipe temp. sensor for indoor unit A	28	30	4	8
Malfunction of liquid pipe temp. sensor for indoor unit B	29	31	4	9
Malfunction of liquid pipe temp. sensor for indoor unit C	30	32	5	0
Malfunction of liquid pipe temp. sensor for indoor unit D	31	33	5	1
Malfunction of gas pipe temp. sensor for indoor unit A	32	34	5	2
Malfunction of gas pipe temp. sensor for indoor unit B	33	35	5	3
Malfunction of gas pipe temp. sensor for indoor unit C	34	36	5	4
Malfunction of gas pipe temp. sensor for indoor unit D	35	37	5	5
Malfunction of gas pipe temp. sensor for indoor unit E	36	38	5	6
Malfunction of module temp.sensor Momentary power failure detection	38	3A	5	8
Malfunction of condensing temp. sensor	39	3B	5	9
Malfunction of liquid pipe temp. sensor for indoor unit E	40	3C	6	0
Malfunction of 'Toci' temp. sensor	41	3D	6	1
System high pressure switch off	42	3E	6	2
System low pressure switch off	43	3F	6	3
System high pressure protection.Refrigerant overabundance,High condensing temp. or malfunction of fan motor.	44	40	6	4
System low pressure protection.Refrigerant shortage, Low defrosting temp., or malfunction of fan motor.	45	41	6	5



Haier

Address: Haier Industrial Park, Qianwangang Road, Eco-Tech Development Zone, Qingdao 266555, Shandong, P.R.C.

Contacts: TEL +86-532-88936943; FAX +86-532-8893-6999

Website: www.haier.com